



**BLUEBIRD  
INDUSTRIES**

**NATURALLY TOGETHER.**



**Blue Bird Industries Benelux**



**MDS BV**

**Eikenstraat 15 bus 1**

**BE 2840 Reet**

**Tel: +32 (0)3 888 23 51**

**+31 (0)488 455 060**

**E-mail: [info@mdsbv.eu](mailto:info@mdsbv.eu)  
[service@mdsbv.eu](mailto:service@mdsbv.eu)**

**Internet site : [www.mdsbv.eu](http://www.mdsbv.eu)**

**Bank: BNP Paribas Fortis  
- BIC: GEBABEBB  
- IBAN: BE93001872514167**

**Nr. VAT: BE0466649083**





**NATURALLY  
TOGETHER.**

**PRODUCTS CATALOG  
2024**

Les prix dans ce catalogue ne nous engagent pas  
Veuillez consulter à chaque fois notre site  
[www.mdsbv.eu](http://www.mdsbv.eu)

De prijzen in deze catalogus binden ons niet.  
Gelieve telkens onze website te raadplegen  
[www.mdsbv.eu](http://www.mdsbv.eu)

Die Preise in diesem Katalog sind für uns  
unverbindlich. Bitte konsultieren Sie immer unsere  
Website [www.mdsbv.eu](http://www.mdsbv.eu)

The prices in this catalog do not bind us. Please  
always consult our website [www.mdsbv.eu](http://www.mdsbv.eu)

A scenic landscape featuring a river in the foreground, a dense forest of evergreen trees in the middle ground, and misty mountains in the background. The scene is overlaid with a series of seven downward-pointing chevrons, each containing a different natural element: the top chevron shows a close-up of tree roots, the second shows a misty forest, the third shows a dense evergreen forest, the fourth shows a sunlit forest clearing, the fifth shows a river with reflections, the sixth shows a close-up of a tree trunk, and the bottom chevron shows tall grass. The text "Where nature is the protagonist" is written in a white, cursive font across the middle of the chevrons.

*Where nature  
is the protagonist*





## OUR MISSION

We are keen to engender the fulfilment of our customers and partners by making the best machinery for green care and by providing all our energy and assistance. We believe in people, the value of work, and the strength of partnership. We are an independent company aiming to continue building a common future.

# BLUE BIRD PLANET

Blue Bird produces a complete range of machines and Accessories for garden care and maintenance, forestry work, and agriculture.

Whether you are a private or a professional you will find tools, advices and assistance because Blue Bird is a planet where nature is the protagonist along with everything you need to take care of it.





## 2024: ENLARGE YOUR HORIZONS

The new Blue Bird range is aimed at passions and to professionals who want to broaden their horizons in landscaping care. From battery-powered machinery to technical clothing, each product offers new guarantees in terms of performance, durability and reliability.

# NATURALLY TOGETHER

Together is a word that fully represents Blue Bird: together in the company, together with our retailers, together with everyone who uses our products. Blue Bird is there. Close to nature and people, of course!

We are very determined: everyone who will use one of our machines must have immediate benefits, satisfaction, greatly facilitated work, and a complete pre-sales and after-sales support. Every machine is meant to prove to be a reliable and loyal partner, just like Blue Bird.





*Enlarge  
the horizons  
in the care of  
greenery*



# We are Blue Bird

## WHY CHOOSE BLUE BIRD.



### INDEPENDENCE AND RESPONSIBILITY

We are an Italian company, solid and independent, not linked to multinationals. We are independent in our choices, investments, and production processes, and we take responsibility for them.



### FAMILY AND COMPANY

We like to define ourselves as a family company. Because the company is led by Vanda Vitella, the founder's daughter, because decisions are not dropped from above, because there is collaboration and sharing among colleagues, because the determination to grow together is pursued by everyone.



### TALENT AND PEOPLE

We believe in work as a value for the individual and for society. That is why we give space to young people and make sure to bring out, cultivate and reward everyone's talent, for the benefit of all and to generate fertile and lasting work.



### LISTENING AND COMPETENCE

To make our products, we listen to our customers' needs because we want to improve the quality of their lives. We are helped by our attention to change, all-Italian creativity, and streamlined and efficient production processes.





## RELIABILITY AND FAIRNESS

We are used to giving our word to customers, personnel, retailers, suppliers, and stakeholders and keeping it. We have long-lasting relationships and partnerships based on trust..



## ENVIRONMENT AND FUTURE

Living in contact with green, breathing nature is good for health and creates well-being. Our "pact" with the planet pays attention to the present, with comprehensive resource management, and to the future, with the study of projects dedicated to the schools and professionals of tomorrow.i.



## THE COMPANY IN NUMBERS

235

products

1200

retailers

130K

satisfied customers

2,5MLN

smiles

The latest addition is the line of machines powered by long-lasting, interchangeable lithium batteries.

Our constantly updated range includes petrol engines, brush cutters, lawn edgers, lawn mowers, vacuums cleaners/blowers, hedge trimmers, lawn tractors, lawnmowers, bio-wood chippers, chainsaws, winches, log splitters, pruners, scissors, Olive shakers, earth augers, motor tillers, crawler carriers, motor pumps and many Accessories.

With the new European regulations coming in, which limit the emission of unburned gases into the atmosphere from Engines, Blue Bird has designed and developed a new range of five environmentally friendly Engines..

# OUR PRODUCTS



*Become part of  
Blue Bird planet*





## MACCHINE A BATTERY

Batterymachines	PAG 14
Shaft Extension	PAG 34
Accessories	PAG 36



## PRATO & CESPUGLI

Brushcutters	PAG 40
Hedge Trimmers	PAG 56
Blowers / Sprayers	PAG 60
Lawn Mowers / Scarifiers	PAG 62
Lawn Tractors / Rider	PAG 70
Large Surface Mowers	PAG 74
Wheeled Brushcutters	PAG 78
Remote Control	PAG 84
Flail Mowers	PAG 86



## WOOD

Chainsaws / Pruner	PAG 90
Winches	PAG 98
Log Splitters	PAG 100
Shredders	PAG 104
Wood Chippers	PAG 106
Saw Benches	PAG 110



## FARMING

Olive Harvesters	PAG 114
Olive Shakers	PAG 116
Carriers	PAG 118



## SOIL

Mini Excavator	PAG 124
Earth Augers	PAG 126
Motor Drills	PAG 130
Motor Tillers	PAG 132



## WATER

Motor pumps	PAG 138
-------------	---------



## DEVICES OF PERSONAL PROTECTION & GADGET

Devices of personal protection	PAG 144
Gadget	PAG 146



## WINNING COMBINATION, PERFECT RESULTS.

One of the winning features of Blue Bird battery powered machines is the great adaptability. The different gardening and maintenance jobs can be tackled sequentially since the Blue Bird system allows you to use only one battery for multiple products, without compromising performance. Ease of use and low maintenance are standard.

From precision scissors to pruner, from brushcutters to lawn mower, from lawn tractor, from blowers to hedge trimmers, without forgetting the more specific products such as the tool for tying vine shoots, Blue Bird Battery machines make every job easier. We guarantee low levels of vibration despite the high and constant power. The new frontier of battery machines is here: the Blue Bird system is a new way to work more free and with greater efficiency.





## **PRACTICES RELIABLE POWERFUL**

The Blue Bird battery range is the most appropriate answer for the multiple needs of green care. Whether it is professional work on large areas or interventions confined to small private areas, the battery machines are essential to facilitate and speed up the action.

*Unstoppable  
energy*

# **BATTERY MACCHINE**

Batterymachines	PAG 14
Battery platform BP 126	PAG 15
Battery platform BP 168	PAG 18
Battery platform BP 210	PAG 22
Battery platform BP 240	PAG 28
Battery platform BP 504	PAG 28
Battery platform BP 504	PAG 29
Shaft Extension	PAG 34
Accessories	PAG 36

# Only one battery for more products

## BATTERY MACHINES



### BATTERY PLATFORM BP 84

#### BATTERY PLATFORM BP 84

The BP84 battery platform with maximum voltage of 8.4V it is compatible with the PS 22-23 TWIN pruning shear, suitable for a quick and easy pruning.

Lithium Battery BT 84-2	<b>COD. 451970</b>	<b>€ 18,15*</b>
Charger	<b>COD. 5022001400000</b>	<b>€ 45,98*</b>



### PS 22-23 TWIN



BATTERY  
PRO 8.4 V

	<b>COD. 885930</b>
Working voltage	7.2 V
Maximum voltage	8.4 V
Cutting diameter	23 mm max
Cutting options	2 openings + progressive cut
Cutting time	0.4 sec
Lithium Battery	n. 1 included - 8.4 V - 2 Ah
Charging time	2.5 - 4.5 h
Weight battery included	830 gr
<b>Retail price</b>	<b>€ 140 - € 169,40*</b>







# BATTERY PLATFORM BP 126

## BATTERY PLATFORM BP 126

The BP 126 battery platform with maximum voltage of 12.6V powers different Blue Bird products making multiple pruning operations possible through a single accessory.

Lithium Battery BT 126-2.5	<b>COD. 451920</b>	<b>€ 42,35*</b>
Charger	<b>COD. 451940</b>	<b>€ 54,45*</b>



## CS 22-04



BATTERY  
PRO 12.6 V

### COD. 885610

Engine	Brushless
Working voltage	10.8 V
Maximum voltage	12.6 V
Maximum power	250 W
Lithium Battery	n. 2 included - 12.6V 2.5Ah
Bar	4"
Chain	1/4 - 1.1 mm - 29 drive links
Cutting size	100 mm
Speed	variable
Weight battery included	1 kg
<b>Retail price</b>	<b>€ 190 - € 229,90*</b>

*Guaranteed power*



## PCS 22-06



BATTERY  
PRO 12.6 V

### COD. 887390

Engine	Brushless
Maximum voltage	12.6 V
Lithium Battery	n. 2 included - 12.6V - 2.5 Ah
Bar	6"
Chain	1/4" - 1.1 mm - 38 drive links
Charging time	2.5 - 3.5 h
Weight battery included	2.4 kg
<b>Retail price</b>	<b>€ 295 - € 356,95*</b>



# GC 22-10



- 01. Grass trimmer head**
- 02. Hedge trimmer head:** suitable for maintaining domestic hedges.
- 03. Ergonomic handle allows** you to grip the scissors without difficulty for particularly easy cutting.
- 04. Hand protection.**

**COD. 888080**

Working voltage	10.8 V
Maximum voltage	12.6 V
Engine	Brushless
Power	120 W
Cutting tools	Shears + Hedge trimmers
Shears cutting width	109 mm
Blade Hedge trimmers	139 mm
Speed regulation	3 Speed
Battery	Lithium battery 12.6 V - 2.5 Ah
Equipment included	1 battery + charger + tools
Shaft	Optional
Weight (machine)	1000 gr
Weight (battery)	200 gr
<b>Retail price</b>	<b>€ 125 - € 151,25*</b>

**COD. 7200180**

Shaft EP 22-10	
<b>Retail price</b>	<b>€ 42 - € 50,82*</b>

*Precision is important*



01. Grass trimmer head

03. Ergonomic handle



02. Hedge trimmer head

04. Hand protection

# SG 22-10



## SPRAYER

**COD. 887410**

Engine	Brushless
Maximum voltage	12.6 V
Lithium Battery	n 1 included - 12.6 V - 2.5 Ah
LED	6 LED UV
Fuel tank	1 lt
Maximum pressure	10 bar
Throw adjustment	3 modes
Charging time	3 - 4 h
Weight	600 gr (sprayer) + 200 gr (battery)
<b>Retail price</b>	<b>€ 105 - € 127,05*</b>





# PS 23-25 FASTER



BATTERY  
PRO 12.6 V



**+30%**  
Speed



**+10%**  
Power



**25mm**  
ø max

**COD. 888380**

Working voltage	10.8 V
Maximum voltage	12.6 V
Cutting diameter	25 mm max
Cutting options	2 openings + progressive cut
Lithium Battery	n. 2 included 12.6 V - 2 Ah
Charging time	2.5 - 4.5 h
Weight battery included	900 gr
<b>Retail price</b>	<b>€ 190,00 - € 229,90*</b>





## BATTERY PLATFORM BP 168

### BATTERY PLATFORM BP 16.8V

The BP 168 battery platform with maximum voltage of 16.8V powers different Blue Bird products making multiple pruning operations possible through a single accessory.

Lithium Battery BT 168-2.5C for CS 22-06	<b>COD. 50305000140000</b>	<b>€ 60,50*</b>
Lithium Battery BT 168-2.5	<b>COD. 451860</b>	<b>€ 60,50*</b>
Charger	<b>COD. 5022001052000</b>	<b>€ 48,40*</b>
Charger for CS 22-06	<b>COD. 5022001059000</b>	<b>€ 48,40*</b>

## CS 22-06



BATTERY  
PRO 16.8 V

**COD. 887420**

Engine	With brushes
Working voltage	14.1 V
Maximum voltage	16.8 V
Maximum power	220 W
Lithium Battery	n. 2 included - 16.8 V 2.5Ah
Bar	5"
Chain	1/4 - 1.1 mm - 34 drive links
Oil tank	16 ml
Oil pump	manual
Charging time	2.5 - 3.5 h
Weight battery included	1.4 kg
<b>Retail price</b>	<b>€ 225 - € 272,25*</b>



## PS 23-28 FASTER



**COD. 888580**

Working voltage	14.4 V
Maximum voltage	16.8 V
Cutting diameter	28 mm max
Cutting options	2 openings + progressive cut
Lithium Battery	n. 2 included - 16.8 V - 2.5 Ah
Charging time	3 - 4 h
Weight battery included	970 gr
<b>Retail price</b>	<b>€ 235 - € 284,35*</b>



**+30%**  
Speed



**+10%**  
Power



**28mm**  
ø max









# PS 22-32C



BATTERY  
PRO 16.8 V

*Time for pruning*

**COD. 884360**

Working voltage	14.4 V
Maximum voltage	16.8 V
Cutting diameter	32 mm max
Cutting options	2 openings + progressive cut
Cutting time	0.4 sec
Lithium Battery	n. 3 included - 16.8 V - 2.5 Ah
Charging time	3 - 4 h
Weight con battery included	970 gr
<b>Retail price</b>	<b>€ 375 - € 453,75*</b>



# PS 23-35 FASTER



BATTERY  
PRO 16.8 V



**+30%**  
Speed



**+10%**  
Power



**35mm**  
ø max

**COD. 888590**

Working voltage	14.4 V
Maximum voltage	16.8 V
Cutting diameter	35 mm max
Cutting options	2 openings + progressive cut
Lithium Battery	n. 3 included - 16.8 V - 2.5 Ah
Charging time	3 - 4 h
Weight battery included	970 gr
<b>Retail price</b>	<b>€ 395 - € 477,95*</b>





# PT 23-200



- Indispensable machine for quickly tying vine shoots in small/medium sized vineyards.
- Allows a reduction of working time of more than 50% compared to manual tying.
- Suitable for vineyards, fruit trees and vegetables that need fixing to supports.

*A deep bond*



**TYING CABLE REEL**  
PT 23-200 **BIO PVC** 200 mt

COD. 571760 € 3 - € 3,63\*

**COD. 888370**

Working voltage	14.4 V
Maximum voltage	16.8 V
Lithium Battery	n. 2 - 16.8 V - 2 Ah included
Rated Power	30 W
Maximum Power	50 W
Diameter	30 mm
<b>Retail price</b>	<b>€ 310 - € 375,10</b>





# BATTERY PLATFORM BP 210

## BATTERY PLATFORM BP 168

The BP 210 battery platform with maximum voltage of 21V powers different Blue Bird products making multiple operations possible through a single accessory.

Lithium Battery BT 210-2.5 for CS 22-06 TIMBER	<b>COD. 452060</b>	<b>€ 66,55*</b>
Lithium Battery BT 210-5	<b>COD. 451950</b>	<b>€ 114,95*</b>
Standard Charger	<b>COD. 5033001120000</b>	<b>€ 54,45*</b>
Quick Charger	<b>COD. 8040001076000</b>	<b>€ 90,75*</b>



# BC 22-800 L



BATTERY  
PRO 21 V

## COD. 887860

Working voltage	18 V
Maximum voltage	21 V
Engine	Brushless
Battery	Lithium Battery 21 V - 5 Ah
Handle	Loop
Speed	3 Speed
Cutting head	Included, cutting ø 340-380 mm
Equipment included	1 battery + Charger + tools
Weight	3.8 kg
<b>Retail price</b>	<b>€ 370 - € 447,70</b>



# COMBI 22-800



BATTERY PRO  
21 V

## MULTI-TOOL KIT

## COD. 887870

Working voltage	18 V
Maximum voltage	21 V
Engine	Brushless
Power	800 W
Brushcutter	Included
Hedge trimmers	Included
Pruner	Included
Shaft extension	Included
Battery	Lithium battery 21 V - 5 Ah
Equipment included	1 battery + Charger + tools
<b>Retail price</b>	<b>€ 520 - € 629,20*</b>





# LM 22-41



BATTERY  
PRO 21 V

**COD.888260**

Working voltage	18 V
Maximum voltage	21 V
Engine	Brushless
Battery	Lithium Battery 2 x 21 V-5 Ah included
Equipment	2 batteries + charger included
Traction	No
Cutting width	41 cm
Cutting height	25-75 mm
Cutting modes	Back discharge / mulching
<b>Retail price</b>	<b>€ 540 - € 653,40*</b>



# LM 22-46 T



BATTERY  
PRO 21 V

**COD. 888270**

Working voltage	18 V
Maximum voltage	21 V
Engine	Brushless
Battery	Lithium Battery 2 x 21 V-5 Ah included
Equipment	2 batteries + charger included
Traction	yes
Cutting width	46 cm
Cutting height	25-75 mm
Cutting modes	Back discharge / mulching
Handle	Telescopic
<b>Retail price</b>	<b>€ 620 - € 750,20*</b>



# HT 22-60



BATTERY  
PRO 21 V

**COD. 887880**

Working voltage	18 V
Maximum voltage	21 V
Engine	Brushless
Power	800 W
Blade length	600 mm
Pitch	32 mm
Speed Modes	3 Speed
Battery	Lithium Battery 21 V – 5 Ah
Equipment included	1 battery + Charger + tools
Weight (machines)	3.5 kg
Weight (battery)	670 gr
<b>Retail price</b>	<b>€ 380 - € 459,80*</b>



# PHT 22-52



BATTERY  
PRO 21 V

**COD. 887490**

Working voltage	18 V
Maximum voltage	21 V
Engine	Brushless
Power	800 W
Blade length	520 mm
Pitch	22.5 mm
Speed Modes	3 Speed
Shaft	Telescopic (from 120 to 240 cm)
Blade inclination	Adjustable up to 180°
Battery	Lithium Battery 21 V – 5 Ah
Equipment included	1 battery + Charger + tools
<b>Retail price</b>	<b>€ 410 - € 496,10*</b>



# BS 22-400



BATTERY  
PRO 21 V

**COD. 887900**

Working voltage	18 V
Maximum voltage	21 V
Engine	Brushless
Power	400 W
Battery	Lithium Battery 21 V – 5 Ah
Equipment	1 battery + Charger included
Max air speed	45 m/s
Max air volume	400 m3/h
Max throw	8 m
Fuel tank	3 litri
Weight (battery)	670 gr
<b>Retail price</b>	<b>€ 420 - € 508,20*</b>





## BL 22-300

**BATTERY  
PRO 21 V**
**COD. 887990**

Working voltage	18 V
Maximum voltage	21 V
Engine	Brushless
Power	300 W
Battery	Lithium Battery 21 V - 5 Ah
Equipment	1 battery + Charger included
<b>Retail price</b>	<b>€ 365 - € 441,65*</b>



## THCS 22-07

**BATTERY  
PRO 21 V**
**COD. 887400**

Engine	Brushless
Working voltage	18V
Maximum voltage	21 V
Lithium Battery	n. 2 included - 21 V - 5 Ah
Bar	8"
Chain	1/4" - 1.1 mm - 48 drive links
Charging time	3 - 4 h
Oil pump	Automatic
Weight with battery included	2.5 kg
<b>Retail price</b>	<b>€ 440 - € 532,40*</b>

*The combination of  
precision and power*



## CS 22-07 / CS 22-06 TIMBER

**BATTERY  
PRO 21 V**
**COD. 887850**
**COD. 888210**

Engine	Brushless	With brushes
Working voltage	18 V	18 V
Maximum voltage	21 V	21 V
Power	750 W	400 W
Chain	1 / 4 " 42 drive links	1 / 4 " 34 drive links
Bar	7" (175 mm)	5"
Sprocket	8 tooth	
Chain speed	11.5 m/s	4,6 m/s
Battery	Lithium Battery 21 V - 5 Ah	Lithium Battery 21 V - 2.5 Ah
Equipment included	1 battery + Charger + tools	1 battery + Charger + tools
Oil pump	Automatic	Manual
Weight battery included	1.7 kg	1.4 kg
<b>Retail price</b>	<b>€ 420 - € 508,20*</b>	<b>€ 240 - € 290,40*</b>



# PCS 23-08 NIMBLER



BATTERY  
PRO 21 V



**COD.888600**

Maximum voltage	21 V
Power	350 W
Battery	4 Ah
Total length	230 cm
Bar and chain	1/4" - 48 tooth - 8"
Sprocket	7 tooth
Chain speed	10.4 m/s
Charger type	USB type C
Weight battery included	2.3 kg
<b>Retail price</b>	<b>€ 215 - € 260,15*</b>



21V- 4 Ah battery included

# PCS 22-10A



BATTERY  
PRO 21 V

**COD. 888440**

Engine	Brushless
Working voltage	18 V
Maximum voltage	21 V
Oil pump	Automatic
Display	LED
Lithium Battery	<b>n. 2</b> included 21 V - 5 Ah
Bar	9"
Chain	1/4" - 1.1 mm - 49 drive links
Minimum length	177 mm
Maximum length	257 mm
Charging time	3 - 4 h
Weight battery included	3.5 kg
<b>Retail price</b>	<b>€ 440 - € 532,40*</b>

*Pruning  
at high altitudes*







## OLIMPO 23-56 / OLIMPO 23-56 AT

	<b>COD. 888040</b>	<b>COD. 888350</b>
Working voltage	18-43.2V	18-43.2V
Maximum voltage	21-50.4V	21-50.4V
<b>Maximum power</b>	<b>1000 watt</b>	<b>1000 watt</b>
<b>Working power</b>	<b>350 watt</b>	<b>350 watt</b>
Working width	500 mm	500 mm
Speed Modes	3 modes	3 modes
Beats per minute	800-1000-1200	800-1000-1200
Shaft	Fixed	Telescopic
Shaft length	2.400 mm	2.250-3.100 mm
Shaft material	carbon	carbon
Working time with battery 21V - 5Ah	2/3 h (no load)	2/3 h (no load)
Working time with backpack battery 50.4V - 18Ah	9 h (no load)	9 h (no load)
Sticks	4+4	4+4
Control panel	Display LCD	Display LCD
Weight (battery excluded)	2.5 kg	2.9 kg
<b>Retail price</b>	<b>€ 320 - € 387,20*</b>	<b>€ 360 - € 435,60*</b>

**The OLIMPO 23-56 and OLIMPO 23-56 AT models are supplied without battery and charger.**

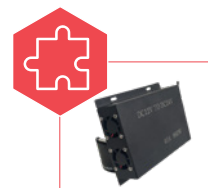

**INVERTER 12V  
+ CABLE 12 MT**

**COD. 452070**

**€ 139,15\***



 On page 117 are presented models EGEO 22-50 and EGEO 22-50 AT olive harvesters with operation via 12V battery.

# BATTERY PLATFORM BP 240

## BATTERY PLATFORM BP 240

The BT 240-2.5 battery with 24V maximum voltage is compatible with the PS 22-38 shears, suitable for high-performance pruning



Lithium Battery BT 240-2.5	<b>COD. 451960</b>	<b>€ 102,85*</b>
Charger	<b>COD. 5022011040000</b>	<b>€ 60,50*</b>



# PS 22-38



BATTERY PRO 24 V



## COD. 885920

Working voltage	21.6 V
Maximum voltage	24 V
Cutting diameter	38 mm max
Cutting options	2 openings + progressive cut
Cutting time	0.4 sec
Lithium Battery	n. 2 included - 24 V - 2.5 Ah
Charging time	2.5 - 4.5 h
Weight battery included	1.3 kg
<b>Retail price</b>	<b>€ 480 - € 580,80</b>



# BATTERY PLATFORM BP 504

## BATTERY PLATFORM BP 540

The BT 504-4P battery with Maximum voltage of 50.4V is compatible with the PS 22-40 prunin shear and CS 22-08 pruner, which guarantees extremely functional pruning thanks to the shoulder battery.

Lithium Battery BT 504-4P	<b>COD. 451910</b>	<b>€ 556,60*</b>
Charger	<b>COD. 5020210930000</b>	<b>€ 66,55*</b>

# PS 22-40 4 AH



BATTERY PRO 50.4 V

	<b>COD. 884230</b>	<b>COD. 888070</b>
Working voltage	43.2 V	43.2 V
Maximum voltage	50.4 V	50.4 V
Cutting diameter	40 mm max	40 mm max
Cutting options	2 openings + progressive cut	2 openings + progressive cut
Cutting time	0.4 sec	0.4 sec
Lithium Battery	n. 1 included 50.4 V - 4 Ah	not included
Charging time	2.5 - 3.5 h	
Weight	2.5 kg battery included	1.5 kg battery excluded
<b>Retail price</b>	<b>€ 1.022,45*</b>	<b>€ 496,10*</b>





# CS 22-08



	<b>COD. 883990</b>	<b>COD. 885890</b>
Engine	Brushless	Brushless
Working voltage	43.2 V	43.2 V
Maximum voltage	50.4 V	50.4 V
Maximum power	1296 W	1296 W
Lithium Battery		43.2 V 4 Ah included
Charger		included
Backpack		included
Bar	7" 1/1	7" 1/1
Chain	1/4 1.1 mm - 48 drive links	1/4 1.1 mm - 48 drive links
Cutting size	150 mm	150 mm
Speed	variable	variable
Weight battery included	850 gr.	1,85 kg
<b>Retail price</b>	<b>€ 430 - € 520,30*</b>	<b>€ 760 - € 919,60*</b>



## BATTERY PLATFORM BP 504

### BATTERY PLATFORM BP 540

The standard and backpack version batteries of this platform with Maximum voltage of 50.4V power different Blue Bird products, making multiple garden care operations possible through the compatibility of a single accessory.

Backpack BT 504-18Z 50.4V 18A/h	<b>COD. 888050</b>	<b>€ 822,80*</b>
Battery BT 504-5 D (display)	<b>COD. 888300</b>	<b>€ 369,05</b>
Battery BT 504-5 WD (without display)	<b>COD. 888310</b>	<b>€ 338,80*</b>
Standard Charger	<b>COD. 452030</b>	<b>€ 66,55*</b>



## BC 23-800 L / BC 23-800 B



	<b>COD. 887920</b>	<b>COD. 887910</b>
Working voltage	43.2 V	43.2 V
Maximum voltage	50.4 V	50.4 V
Engine	Brushless	Brushless
Power	800 W	800 W
Battery*	Lithium Battery 50.4 V - 5 Ah	Lithium Battery 50.4 V - 5 Ah
Handle	Loop	Bike
Cutting modes	3 Speed	3 Speed
Ø shaft	28 mm	28 mm
Cutting head	Included	Included
Blade	Included	Included
<b>Retail price</b>	<b>€ 308,55*</b>	<b>€ 314,60*</b>



**OPTIONAL BACKPACK BATTERY  
50.4 V - 18 Ah**

\* \*Battery and charger not included



## HT 23-70



- Hedge trimmer with 50.4V lithium battery and 800W power.
- 700 mm blades to ensure effective work.
- Handle adjustable on 5 different positions up to 180° to ensure comfort during use.

**COD. 884090**

Working voltage	43.2 V
Maximum voltage	50.4 V
Engine	Brushless
Power	800 W
Battery*	Lithium Battery 50.4 V - 5 Ah
Blade length	700 mm
Pitch	32 mm
Speed Modes	3 Speed
Adjustable handle	180 ° (5 positions)
Weight (machine)	3.5 kg
<b>Retail price</b>	<b>€ 245 - € 296,45*</b>

\* Battery and charger not included

*Easy trimming*



OPTIONAL BACKPACK BATTERY  
50.4 V - 18 Ah

## PHT 23-54



	<b>COD. 887940</b>
Working voltage	43.2 V
Maximum voltage	50.4
Engine	Brushless
Power	800W
Battery*	Lithium Battery 50.4 V - 5 Ah
Blade length	540 mm
Pitch	27 mm
Speed Modes	2 Speed
Blade regulation	Adjustable up to 270°
Weight (machine)	5.7 kg
<b>Retail price</b>	<b>€ 320,00 - € 387,20*</b>

\* Battery and charger not included



OPTIONAL BACKPACK BATTERY  
50.4 V - 18 Ah



# LM 23-51



BATTERY PRO  
50.4 V

**COD. 887890**

Working voltage	43.2 V
Maximum voltage	50.4 V
Engine	Brushless
Rated Power	1400 W
Maximum Power	2500 W
Battery*	Lithium Battery 50.4V - 5 Ah
Cutting width	51 cm
Cutting height	25-75 mm
Speeds	6
<b>Retail price</b>	<b>€ 470 - € 568,70*</b>

\* Battery and charger not included



# BL 23-800



BATTERY  
PRO 50.4 V

**COD. 887970**

Working voltage	43.2 V
Maximum voltage	50.4 V
Engine	Brushless
Power	800 W
Battery*	Lithium Battery 50.4V - 5 Ah
Max air speed	70 m/s
Max air volume	780 m3/h
Speed regulation	3 speed + turbo
<b>Retail price</b>	<b>€ 135 - € 163,35*</b>

\* Battery and charger not included



OPTIONAL BACKPACK BATTERY  
50.4 V - 18 Ah

# CS 23-16



BATTERY  
PRO 50.4V

**COD. 887960**

Working voltage	43.2 V
Maximum voltage	50.4V
Engine	Brushless
Power	2500 W
Battery*	Lithium Battery 50.4 V - 5 Ah
Chain Speed	20 m/s
Bar length	16" (40 cm)
Chain	3 / 8 " 56 drive links
Oil pump	Automatic
Weight (machine)	4.5 kg
<b>Retail price</b>	<b>€ 320 - € 387,20*</b>

\* Battery and charger not included



OPTIONAL BACKPACK BATTERY  
50.4 V - 18 Ah



## PCS 23-10



BATTERY  
PRO 50.4 V

**COD. 887950**

Working voltage	43.2 V
Maximum voltage	50.4 V
Power	1000 W
Battery*	Lithium Battery 50.4 V - 5 Ah
Chain Speed	13 m/s
Bar length	10" (25 cm)
Chain	1 / 4" 48 drive links
Oil pump	Automatic
Shaft length	260 cm
Weight (machine)	5.5 kg
<b>Retail price</b>	<b>€ 320 - € 387,20*</b>

\* Battery and charger not included



OPTIONAL BACKPACK BATTERY  
50.4 V - 18 Ah



## OLIMPO 23-56 / OLIMPO 23-56 AT

**COD. 888040**

**COD. 888350**

Working voltage	18-43.2V	18-43.2V
Maximum voltage	21-50.4V	21-50.4V
<b>Maximum power</b>	<b>1000 watt</b>	<b>1000 watt</b>
<b>Working power</b>	<b>350 watt</b>	<b>350 watt</b>
Working width	500 mm	500 mm
Speed regulation	3 modes	3 modes
Beats per minute	800-1000-1200	800-1000-1200
Shaft	Fixed	Telescopic
Shaft length	2.400 mm	2.250-3.100 mm
Shaft material	carbon	carbon
Working time with battery 21V - 5Ah	2/3 h (no load)	2/3 h (no load)
Working time with backpack battery 50.4V - 18Ah	9 h (no load)	9 h (no load)
Sticks	4+4	4+4
Control panel	Display LCD	Display LCD
Weight (excluded battery)	2.5 kg	2.9 kg
<b>Retail price</b>	<b>€ 320 - € 387,20*</b>	<b>€ 360 - € 435,60*</b>

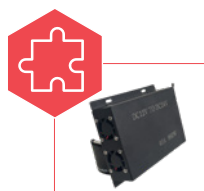

INVERTER 12V  
+ CABLE 12 MT

**COD. 452070**

**€ 139,15\***



The OLIMPO 23-56 and OLIMPO 23-56 AT models are supplied without battery and charger.



*A power never  
seen before*





# SHAFT EXTENSION



- The range includes 1 extension compatible with the CS 22-04 pruner and the PS 22-23, PS 23-25 FASTER shears, one compatible with the PS 22-32C shears and one compatible with the PS 22-38 shears.
- The connection between the shaft and the tool is wireless.
- The shafts extend up to 2 meters allowing you to work in complete safety with your feet on the ground.

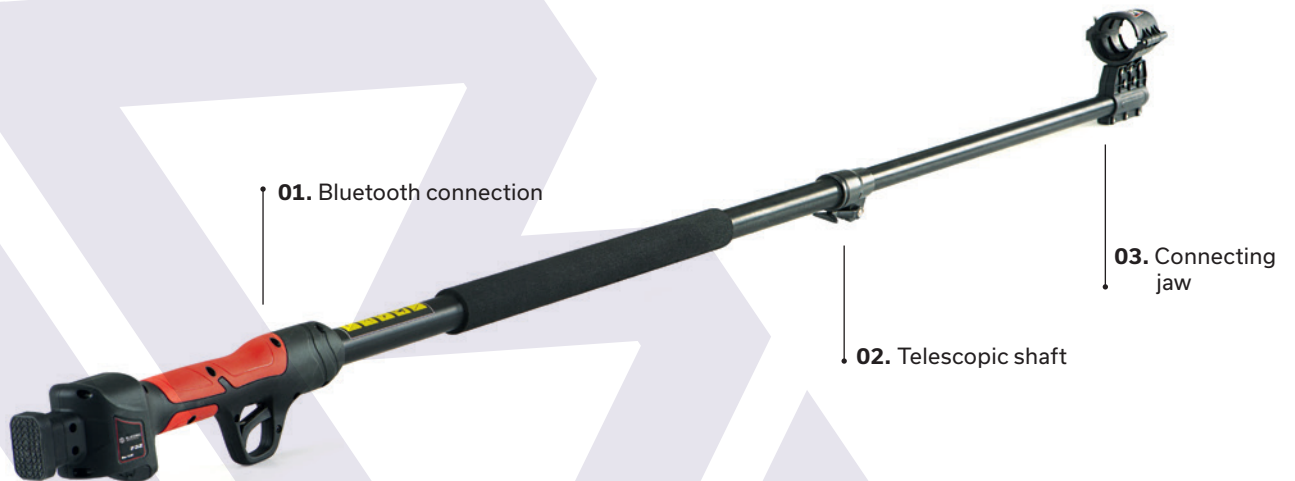

- 01. Bluetooth connection:** allows you to connect scissors and pruners.
- 02. Telescopic attachment:** allows you to extend the pole up to 2 meters.
- 03. Jaw Connecting:** quick tool change.



## EP 22-22

**COD. 7200140**

Shaft extension suitable to	Scissors PS 22-23, PS 23-25 FASTER Pruner CS 22-04
Closed shaft length extension	1.2 mt
Open shaft length extension	2.0 mt
Weight	1.2 kg
<b>Retail price</b>	<b>€ 120 - € 145,20*</b>



SHAFT EXTENSION

## EP 22-32C

**COD. 7200170**

Shaft extension suitable to	Scissor PS 22-32C
Closed shaft length extension	1.5 mt
Open shaft length extension	2.2 mt
Weight	1.2 kg
<b>Retail price</b>	<b>€ 120 - € 145,20*</b>



## EP 22-38

**COD. 7200160**

Shaft extension suitable to	Scissor PS 22-38
Closed shaft length extension	1.5 mt
Open shaft length extension	2.2 mt
Weight	1.2 kg
<b>Retail price</b>	<b>€ 130 - € 157,30</b>



# ACCESSORIES

- Wide range of accessories designed to optimize performance and ensure efficient machine maintenance.
- Our range of battery machine accessories is designed to give you maximum reliability and performance. Made with high-quality materials, our products ensure maximum efficiency of your work
- Green professionals or gardening enthusiasts, Blue Bird accessories are designed to meet your most pretentious needs.



## ECOLOGIC CHAIN PROTECTIVE OIL



5 lt bottle    COD. 210120    € 29,04\*

## VEGETAL CHAIN OIL LT 1



COD. 210280    € 8,47\*

## PROTECTION GOGGLES



COD. 21023    € 9,68





## BARS



CS22-04-BAR	€ 12,58*
CS22-06-BAR	€ 19,72*
CS22-07-BAR	€ 23,35*
CS22-08-BAR	€ 35,94*
PCS22-06-BAR	€ 29,98*
PCS22-10-BAR	€ 35,94*
PCS23-10-BAR	€ 43,20*
THCS22-07-BAR	€ 35,94*

## CHAINS



CS22-04-CHAIN	€ 9,32*
CS22-06-CHAIN	€ 11,50*
CS22-07-CHAIN	€ 15,13*
CS22-08-CHAIN	€ 16,21*
PCS22-06-CHAIN	€ 13,31*
PCS22-10A-CHAIN	€ 16,21*
PCS23-10-CHAIN	€ 19,72*

## POCKET



COD. 754710 € 18,15\*

## UPPER BLADES



UPPER BLADE PS 22-23 TWIN	3040100570000	€ 38,72*
UPPER BLADE PS 22-23 - PS 23-25 FASTER	3040100050000	€ 37,51*
UPPER BLADE PS 21-25 - PS 22-25	3040000200000	€ 37,51*
UPPER BLADE PS 22-32C	3040000000600	€ 38,72*
UPPER BLADE PS 22-38	3040100350000	€ 48,40*
UPPER BLADE PS 22-40	3040000000700	€ 48,40*

## LOWER BLADES



LOWER BLADE PS 22-23 TWIN	3040100045000	€ 31,46*
LOWER BLADE PS 22-23 - PS 23-25 FASTER	3040100040000	€ 31,46*
LOWER BLADE PS 21-25 - PS 22-25	3040100200000	€ 31,46*
LOWER BLADE PS 22-32C	3040100000600	€ 31,46*
LOWER BLADE PS 22-38	3040100340000	€ 48,40*
LOWER BLADE PS 22-40	3040100002000	€ 44,77*



The care and maintenance of vegetation are unthinkable without the basic machines: lawn mowers, large surface mowers, brushcutters and blowers. But also the story of Blue Bird you can't imagine without starting from the brushcutters. They were the first machine produced in 1978 after the development of combustion engines and still are the strength of the company. A history of ingenuity and quality that has expanded over the years with a range of machines that meets all needs..

Advanced technology, Italian design, high quality, handling: the Blue Bird lawn and bushes range must be chosen according to the needs of use and power. Whether it is the lawn at home or a complex work in uncultivated areas, Blue Bird machines are able to cut the time and multiply the results.





## FAMILY TALENT

Blue Bird's lawn & bushes line includes a wide selection of machines for maintaining parks and gardens and for work in uncultivated areas. From cutting to mowing, from bushes to hedges, for every task Blue Bird presents advanced solutions for both private and professional usage. Each machine is designed to give maximum satisfaction to the user.

*Cut out for  
giving our best*

# PRATO & CESPUGLI

Brushcutters	PAG 40
Hedge Trimmers	PAG 56
Blowers / Sprayers	PAG 60
Lawn Mowers / Scarifiers	PAG 62
Lawn Tractors / Rider	PAG 70
Large Surface Mowers	PAG 74
Wheeled Brushcutters	PAG 78
Remote Control	PAG 84
Flail Mowers	PAG 86



# BRUSHCUTTERS

- Blue Bird Industries has designed a range of brushcutters that can satisfy every user and adapt to the most varied needs and working conditions.
- The entire line has been developed in collaboration with professionals who use these machines in the woods, parks and gardens; for this reason, particular attention has been paid to safety, ergonomics and quality, reducing vibrations and noise.
- Every aspect of the engines has been reviewed in detail, making numerous changes and adjustments to optimize performance.



## ST POWER SERIES

The ST POWER series is the result of this careful work, a combination of attention to construction/design details and the choice of the best components.

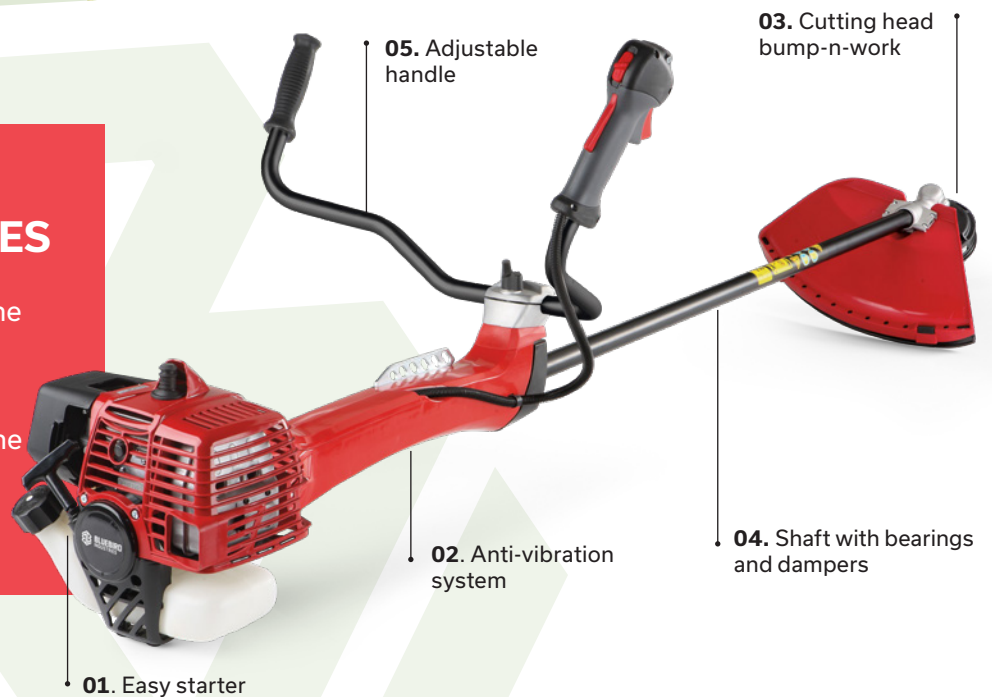

- 01. Easy starting** with minimum effort to make the engine start quick and easy.
- 02. Anti-vibration system** made up of springs and rubber supports which guarantees the damping of vibrations between the shaft and the operator, allowing long periods of work without further fatigue.
- 03. Bump-n-work head** that guarantees a long period of work without having to stop, extracting the line simply with a knock on the ground while the tool is rotating.

- 04. Shaft mounted on bushings and vibration dampers:** the shaft support is made up of 5 self-lubricating bushings mounted on rubber, which guarantee rotation with minimal friction and dampened vibrations to optimize power transmission.
- 05. Adjustable handle** that guarantees the correct position of the operator.





## BC 261 L



**COD. 886000A**

Engine	2-stroke* - 25.4 cc
Power	0.75 kW/7500 rpm
Handle	Loop
Shaft diameter	24 mm
Cutting head	tap & go
Shoulder strap	single
Weight**	5.8 kg
<b>Retail price</b>	<b>€ 270 - € 326,70*</b>



BRUSHCUTTERS

\* 2% mixture with synthetic oil  
\*\* Without fuel, cutting tool and stone guard

## BC 341 L

**COD. 886100A**

Engine	2-stroke* - 33 cc
Power	0.90 kW/7000 rpm
Handle	Loop
Shaft diameter	28 mm
Cutting head	tap & go
Shoulder strap	single
Weight**	6.4 kg
<b>Retail price</b>	<b>€ 290 - € 350,90*</b>



\* 2% mixture with synthetic oil  
\*\* Without fuel, cutting tool and stone guard





## BC 431 L / BC 431 B

	<b>COD. 886200A</b>	<b>COD. 886300A</b>
Engine	2-stroke* - 42.7 cc	2-stroke* - 42.7 cc
Power	1.25 kW/6500 rpm	1.25 kW/8000 rpm
Handle	Loop	Bike
Shaft diameter	28 mm	28 mm
Cutting head	tap & go	tap & go
Shoulder strap	single	single
Weight**	6.6 kg	7.2 kg
<b>Retail price</b>	<b>€ 300 - 363,00*</b>	<b>€ 310 - € 375,10*</b>



\* 2% mixture with synthetic oil  
\*\* Without fuel, cutting tool and stone guard

## BC 280 L / BC 280 B

	<b>COD. 886400A/RO</b>	<b>COD. 886500A/RO</b>
Blue Bird Engine	2-stroke* - 27.4 cc	2-stroke* - 27.4 cc
Power	0.94 kW/8000 rpm	0.94 kW/8000 rpm
Handle	Loop	Bike
Shaft diameter	24 mm	24 mm
Cutting head	tap & go	tap & go
Shoulder strap	single	single
Weight**	6.1 kg	6.7 kg
<b>Retail price</b>	<b>€ 400 - € 484,00*</b>	<b>€ 430 - € 520,30*</b>



\* 2% mixture with synthetic oil  
\*\* Without fuel, cutting tool and stone guard

## BC 300 L



	<b>886960A/RO</b>
Blue Bird Engine	2-stroke* - 27.4 cc
Power	0.94 kW/8000 rpm
Handle	Loop
Shaft diameter	26 mm
Cutting head	tap & go
Shoulder strap	single
Weight**	6.1 kg
<b>Retail price</b>	<b>€ 360 - € 435,60*</b>



\* 2% mixture with synthetic oil  
\*\* Without fuel, cutting tool and stone guard





*News  
never end*

Removable spark plug protector for easy access for maintenance.

Heat protection muffler to further improved comfort of use.

Cylinder cover redesigned for a look all new.

Engine support redesigned to improve the cooling flow.

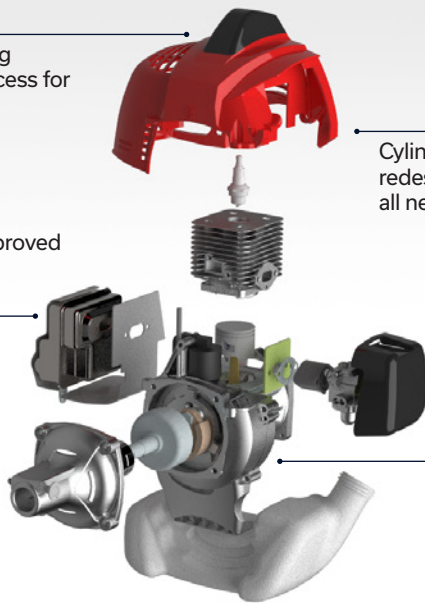

## BC 370 L / BC 370 B

	<b>COD. 886600A/RO</b>	<b>COD. 886700A/RO</b>
Blue Bird Engine	2-stroke* - 34 cc	2-stroke* - 34 cc
Power	1.14 kW/8000 rpm	1.14 kW/8000 rpm
Handle	Loop	Bike
Shaft diameter	28 mm	28 mm
Cutting head	tap & go	tap & go
Shoulder strap	single	single
Weight**	7.0 kg	7.6 kg
<b>Retail price</b>	<b>€ 435 - € 526,35*</b>	<b>€ 445 - € 538,45*</b>



\* 2% mixture with synthetic oil  
\*\* Without fuel, cutting tool and stone guard

## BC 380 L



	<b>886970A/RO</b>
Blue Bird Engine	2-stroke* - 34 cc
Power	1.14 kW/8000 rpm
Handle	Loop
Shaft diameter	28 mm
Cutting head	tap & go
Shoulder strap	single
Weight**	7.0 kg
<b>Retail price</b>	<b>€ 380 - € 459,80*</b>



\* 2% mixture with synthetic oil  
\*\* Without fuel, cutting tool and stone guard



# ST POWER

## VERY DEMANDING? ST POWER IS FOR YOU.

**ST Power is the new series of powerful and reliable machines suitable for those who are not easily satisfied.**

The latest generation of engines developed by the Blue Bird research and development department is the result of painstaking work on every construction detail and on every component. The results are evident at first ignition and last over time, but it is the combustion that gives the greatest satisfaction: more complete and effective, it allows to obtain the desired power while remaining within the EURO V parameters on polluting emissions.

- Power increased by 54%
- Working temperature decreased by 25%
- Torque increased by 63%

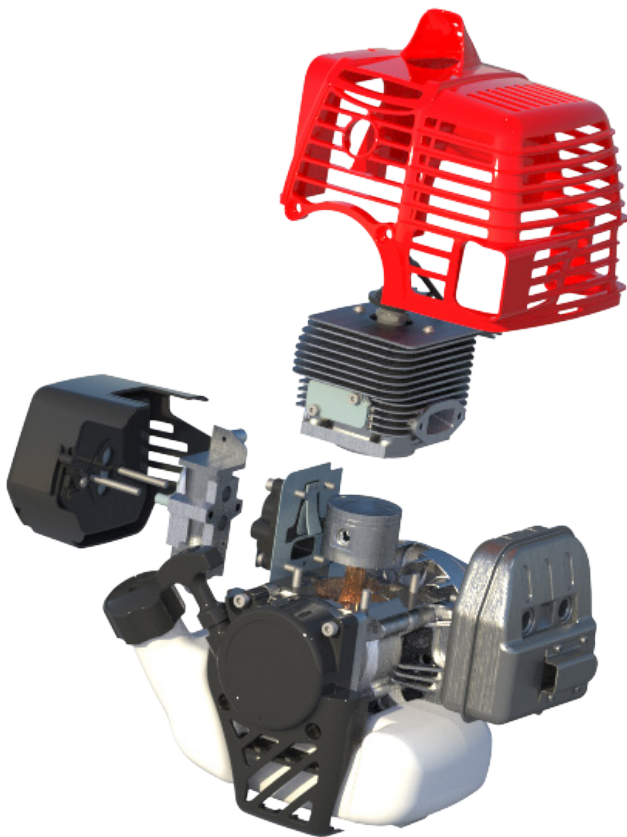

## New power generations

### UNSURPASSED IN RESISTANCE

The ST Power series has been put to the test by professional landscapers teams to verify the resistance of the machines to the stress of heavy use. Blue Bird's goal of ensuring powerful products that last unaltered over time has been rigorously implemented.

After several months in demanding environmental conditions, the ST Power machines demonstrated unchanged power and significantly less wear than expected on all components. All to the advantage of the quality of the work and interventions, which are extremely reduced.

- Unaltered performance even with heavy use
- Power and time do not increase wear
- Maintenance operations drastically reduced

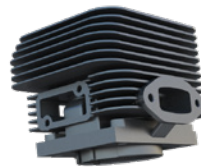

#### CYLINDER

Completely redesigned distribution diagram for 25% more power than the previous model, squish and compression ratio have been revised to increase torque by 63%



#### MAIN BEARINGS

For maximum performance and long life, high smoothness main bearings are used.



#### FLYWHEEL

The flywheel has been modified for a 30% increased air flow. Neodymium magnets used for a more powerful spark and reduced weight.



#### CARBURETOR

New carburetor with increased venturi to ensure the right fuel supply to the engine.





## BC 450 STL / BC 450 STB



	<b>COD. 885770A/RO</b>	<b>COD. 885800A/RO</b>
Engine ST POWER	2-stroke*	2-stroke*
Displacement	44.3 cc	44.3 cc
Power	2 kW/7500 rpm	2 kW/7500 rpm
Handle	Loop	Bike
Shaft diameter	28 mm	28 mm
Cutting head	tap & go	tap & go
Shoulder strap	single	Double
Weight**	7.8 kg	8.2 kg
<b>Retail price</b>	<b>€ 480 - € 580,80*</b>	<b>€ 490 - € 592,90*</b>



\* 2% mixture with synthetic oil  
\*\* Without fuel, cutting tool and stone guard

BRUSHCUTTERS MULTIFUNZIONE

## BC 560 STL / BC 560 STB



	<b>COD. 885780A/RO</b>	<b>COD. 885810A/RO</b>
Engine ST POWER	2-stroke*	2-stroke*
Displacement	53.2 cc	53.2 cc
Power	2.4 kW/7500 rpm	2.4 kW/7500 rpm
Handle	Loop	Bike
Shaft diameter	28 mm	28 mm
Cutting head	tap & go	tap & go
Shoulder strap	single	Double
Weight**	7.8 kg	8.2 kg
<b>Retail price</b>	<b>€ 500 - € 605,00*</b>	<b>€ 510 - € 617,10*</b>



\* 2% mixture with synthetic oil  
\*\* Without fuel, cutting tool and stone guard

## BC 610 STL / BC 610 STB



	<b>COD. 885790A/RO</b>	<b>COD. 885820A/RO</b>
Engine ST POWER	2-stroke*	2-stroke*
Displacement	57.9 cc	57.9 cc
Power	2.8 kW/7500 rpm	2.8 kW/7500 rpm
Handle	Loop	Bike
Shaft diameter	28 mm	28 mm
Cutting head	tap & go	tap & go
Shoulder strap	single	Double
Weight**	7.8 kg	8.2 kg
<b>Retail price</b>	<b>€ 520 - € 629,20*</b>	<b>€ 530 - € 641,30*</b>



\* 2% mixture with synthetic oil  
\*\* Without fuel, cutting tool and stone guard



## BC 450 / 560 / 610 ST PRO



	<b>COD. 885830A/RO</b>	<b>COD. 885840A/RO</b>	<b>COD. 885850A/RO</b>
Engine ST POWER	2-stroke*	2-stroke*	2-stroke*
Displacement	44.3 cc	53.2 cc	57.9 cc
Power	2 kW/7500 rpm	2.4 kW/7500 rpm	2.8 kW/7500 rpm
Handle	Bike	Bike	Bike
Shaft diameter	28 mm	28 mm	28 mm
Cutting head	tap & go	tap & go	tap & go
Shoulder strap	Double	Double	Double
Weight**	8.8 kg	8.8 kg	8.8 kg
<b>Retail price</b>	<b>€ 530 - € 641,30*</b>	<b>€ 555 - € 671,55*</b>	<b>€ 580 - € 701,80</b>



\* 2% mixture with synthetic oil  
\*\* Without fuel, cutting tool and stone guard

## BCB 450 / 560 / 610 STL



	<b>COD. 885860/RO</b>	<b>COD. 885870/RO</b>	<b>COD. 885880/RO</b>
Engine ST POWER	2-stroke*	2-stroke*	2-stroke*
Displacement	44.3 cc	53.2 cc	57.9 cc
Power	2 kW/7500 rpm	2.4 kW/7500 rpm	2.8 kW/7500 rpm
Handle	Loop	Loop	Loop
Shaft diameter	27 mm	27 mm	27 mm
Cutting head	tap & go	tap & go	tap & go
Shoulder strap	backpack	backpack	backpack
Weight**	12.2 kg	12.2 kg	12.2 kg
<b>Retail price</b>	<b>€ 585 - € 707,85*</b>	<b>€ 600 - € 726,00*</b>	<b>€ 620 - 750,20*</b>



\* 2% mixture with synthetic oil  
\*\* Without fuel, cutting tool and stone guard







# COMBI BCB 560 ST



**COD. 885730/RO**

Engine ST POWER	2-stroke*
Displacement	53.2 cc
Power	2.4 kW/7500 rpm
Shaft diameter	26 mm
Cutting head	tap & go
Blade	included
Shoulder strap	backpack
Weight**	12.2 kg
<b>Retail price</b>	<b>€ 640 - € 774,40*</b>

\* 2% mixture with synthetic oil \*\* Without fuel, cutting tool and stone guard



**THE KIT INCLUDES ALL ACCESSORIES LISTED ON PAGE 49**

BRUSHCUTTERS ACCESSORIES

# COMBI 261 / 341

**COD. 885010**

**COD. 885020**

Engine	2-stroke* - 25.4 cc	2-stroke* - 32.6 cc
Power	0.72 kW/7000 rpm	0.92 kW/7000 rpm
Handle	Loop	Loop
Shaft diameter	26	26
Weight**	4.5 kg	4.9 kg
<b>Retail price</b>	<b>€ 300 - € 363,00*</b>	<b>€ 320 - 387,20*</b>

\* 2% mixture with synthetic oil \*\* Without fuel, cutting tool and stone guard



**THE KIT INCLUDES ALL ACCESSORIES LISTED ON PAGE 49**

# COMBI 280 / 370

**COD. 878320A/RO**

**COD. 878330A/RO**

Engine	P28E - 2-stroke* - 27.4 cc	P35E - 2-stroke* - 34 cc
Power	0.94 kW/8000 rpm	1.14 kW/8000 rpm
Handle	Loop	Loop
Shaft diameter	24 mm	24 mm
Weight**	5.3 kg	5.3 kg
<b>Retail price</b>	<b>€ 620 - € 750,20*</b>	<b>€ 640 - € 774,40*</b>

\* 2% mixture with synthetic oil \*\* Without fuel, cutting tool and stone guard



**THE KIT INCLUDES ALL ACCESSORIES LISTED ON PAGE 49**







# MULTI-TOOL ACCESSORIES



In addition to producing the most varied types of brushcutters, Blue Bird Industries offers a wide range of accessories for these machines, thus always guaranteeing the right tool for every type of job.

Among the accessories there is the chain pruner, indispensable for perfect limbing; the hedge trimmer kit, to be applied to the brushcutter shaft to cut hedges and bushes even at great heights and at the most diverse angles; various types of handles, belts, helmets, face shields, goggles and headphones. Finally, not to forget the handy bellows grease nipples for gearbox and the cans of synthetic oil essential for an excellent quality mixture, which guarantees the longevity of your engines.



BRUSHCUTTERS ACCESSORIES

## CHAIN PRUNER



**COD. 727350**   **COD. 730020**

Shaft diameter	24 mm	26 mm
Retail price	€ 121,00*	€ 121,00*

## HEDGE TRIMMER



**COD. 727340**   **COD. 730010**

Shaft diameter	24 mm	26 mm
Retail price	€ 121,00*	€ 121,00*

## SHAFT EXTENSION



**COD. 727360**   **COD. 730040**

Shaft diameter	24 mm	26 mm
Retail price	€ 31,46*	€ 31,46*

## BRUSHCUTTER



**COD. 727330**   **COD. 730000**

Shaft diameter	24 mm	26 mm
Retail price	€ 90,60*	€ 90,60



# BRUSHCUTTERS ACCESSORIES

## HEDGE TRIMMER KIT



**COD. 725030**      **COD. 725040**

Ø shaft	24 mm	27 mm
<b>Retail price</b>	<b>€ 380 - 459,80*</b>	<b>€ 390 - 471,90*</b>

## CHAIN PRUNER

Bar length 10" - chain 3/8"  
low profile 38 drive links



Ø shaft 24 mm      **COD. 725300**      **€ 170 - € 205,70\***

## WEEDER



**COD. 731130**      **COD. 731140**

Accessories	W2	W4
<b>Retail price</b>	<b>€ 175 - € 211,75*</b>	<b>€ 205 - € 248,05*</b>

## SHOULDER STRAP



Ø 24 / 27 / 28 mm      **COD. 751580**      **€ 6 - € 7,26\***

## DOUBLE PROFESSIONAL SHOULDER STRAP



5 adjustments	<b>COD. 751630</b>	<b>€ 10 - € 12,10*</b>
with protection	<b>COD. 754770/YJ</b>	<b>€ 26 - € 31,46*</b>

## PROFESSIONAL FACE SHIELD



polycarbonate	<b>COD. 751840</b>	<b>€ 9 - € 10,89*</b>
metallic net	<b>COD. 751860</b>	<b>€ 9 - € 10,89*</b>

## SYNTHETIC OIL

FOR 2-STROKE ENGINES



**RED  
PROFESSIONAL**

25 bottles 100 ml	<b>COD. 725410</b>	<b>€ 78,65*</b>
1 lt bottle	<b>COD. 210080</b>	<b>€ 15,73*</b>

FOR 2-STROKE ENGINES



**BLUE  
SUPER  
PROFESSIONAL**

25 bottles 100 ml	<b>COD. 731090</b>	<b>€ 106,48*</b>
1 lt bottle	<b>COD. 210360</b>	<b>€ 26,62*</b>

## GREASER



25 dispensers x 50 gr	<b>COD. 724060</b>	<b>€ 68,97</b>
--------------------------	--------------------	----------------





# BRUSHCUTTERS ACCESSORIES



BRUSHCUTTERS ACCESSORIES

## FLASH WORK CUTTING HEAD



Pitch m 10x1 F  
Pitch m 10x1,25 F **COD. 732130** € 24,20\*

## ADAPTER BOLTS FOR FLASH WORK CUTTING HEAD

M7x1 SX M	<b>COD. K00401045</b>	€ 2,40*
M8x1,25 SX F	<b>COD. K00401046</b>	€ 2,40*
M8x1,25 SX M	<b>COD. K00401061</b>	€ 2,40*
M10x1 SX F	<b>COD. K00401047</b>	€ 2,40*
M10x1,25 SX M	<b>COD. K00401048</b>	€ 2,40*
M10x1,25 SX F	<b>COD. K00401062</b>	€ 2,40*
M10x1,5 SX M	<b>COD. K00401049</b>	€ 2,40*
M10x1,5 SX F	<b>COD. K00401050</b>	€ 2,40*
M12x1,25 SX F	<b>COD. K00401051</b>	€ 2,40*
M12x1,5 SX F	<b>COD. K00401052</b>	€ 2,40*
M12x1,75 SX F	<b>COD. K00401053</b>	€ 2,40*
3/8-24F SX F	<b>COD. K00401054</b>	€ 2,40*
M14x1,5 SX F	<b>COD. K00401057</b>	€ 2,40*

## CUTTING HEAD BUMP-N-WORK



Ø 130 M10x1 SX F	<b>COD. 733020</b>	€ 10,70*
Ø 130 Pitch m 8x1,25 FSX	<b>COD. 733160</b>	€ 10,70*
Ø 130 Pitch m 10x1,25 FSX	<b>COD. 733170</b>	€ 10,70*
Ø 130 Pitch m 8x1,25 MSX	<b>COD. 733190</b>	€ 10,70*
Ø 130n o pitch	<b>COD. 733080</b>	€ 10,10*
Ø 109 M10x1 SX F	<b>COD. 733290</b>	€ 10,10*
Ø 109 no pitch	<b>COD. 733090</b>	€ 9,50*

## UNIVERSAL BUMP-N-WORK CUTTING HEAD



Ø 130 universal **COD. 733240** € 18,15\*

## CUTTING HEAD KNOB



reinf.35 mm	<b>COD. K00401080A</b>	€ 8,55*
free wheel	<b>COD. K99900492</b>	€ 11,33*
reinf.55 mm	<b>COD. K00401253</b>	€ 8,75*

## TORNADO CUTTING HEAD

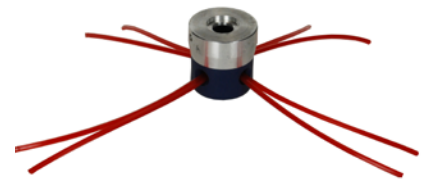

**COD. 20052** € 19,94\*

## CICLONE CUTTING HEAD

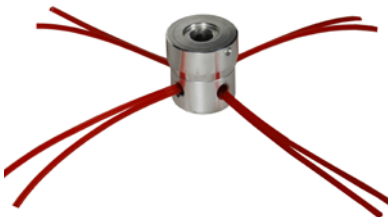

**COD. 20056** € 22,39\*

## SPEED UNIVERSAL CUTTING HEAD



aluminium 2 lines	<b>COD. 752950</b>	€ 47,19*
aluminium 4 lines	<b>COD. 752960</b>	€ 58,08*

## TRIMMING LINE CUTTER



175 pcs boxes **COD. 546910** € 1,21\*



## BRUSHCUTTERS ACCESSORIES

### 2-TOOTH GRASS CUTTING BLADE



SKS5 steel 255x1.6	<b>COD. 600300</b>	<b>€ 6,05*</b>
SKS5 steel 300x1.8	<b>COD. 600660</b>	<b>€ 8,47*</b>
steel 300x3	<b>COD. 600830</b>	<b>€ 8,47*</b>
Busatis steel 305x3	<b>COD. 600630</b>	<b>€ 21,78*</b>
Unbreakable nylon 255x3	<b>COD. 600120</b>	<b>€ 2,42*</b>

### 2-TOOTH MULCHING BLADE



Mulching 300x3	<b>COD. 600820</b>	<b>€ 13,31*</b>
----------------	--------------------	-----------------

### 3-TOOTH GRASS CUTTING BLADE



SKS5 steel 255x1.4	<b>COD. 600250</b>	<b>€ 13,31*</b>
steel 38 CBI 250x3	<b>COD. 600600</b>	<b>€ 10,89*</b>
steel 38 CBI 300X3	<b>COD. 600610</b>	<b>€ 14,52*</b>
Unbreakable nylon 255x3	<b>COD. 600130</b>	<b>€ 3,63</b>

### 4-TOOTH GRASS CUTTING BLADE



SKS5 steel 255x1.4	<b>COD. 600050</b>	<b>€ 10,89*</b>
Unbreakable nylon 255x3	<b>COD. 600140</b>	<b>€ 3,63*</b>

### 8-TOOTH GRASS CUTTING BLADE



SKS5 steel 255x1.4	<b>COD. 600040</b>	<b>€ 12,10*</b>
--------------------	--------------------	-----------------

### CIRCULAR SAW GRASS CUTTING BLADE



SKS5 steel 255x1.4	<b>COD. 600060</b>	<b>€ 12,10*</b>
--------------------	--------------------	-----------------

### WIDIA CIRCULAR SAW BLADE



Widia Ø 255x2	<b>COD. 600640</b>	<b>€ 25,41*</b>
---------------	--------------------	-----------------



*High resistance,  
professional use*



## **CORALLO NYLON LINE**

In the range of Blue Bird Industries Accessories, nylon line is among the essential ones.

Our CORALLO thread stands out for its resistance and diameter which varies from 1.6 to 6 mm.

Depending on the use we have various types available: with round, square or star section. The length is also available in various models: from the 9/15 m bag up to the 10 kg reels..



# BRUSHCUTTERS ACCESSORIES

## ROUND SHAPE NYLON LINE



	1.6	2.0	2.4	2.7	3.0	3.3	4.0	5.0	6.0
mt 15 COD. 542700 € 2, - € 2,42*	mt 15 COD. 542710 € 2,5 - € 3,03*	mt 15 COD. 542720 € 2,9 - € 3,51*	mt 15 COD. 545270 € 3,3 - € 3,99	mt 15 COD. 543580 € 3,8 - € 4,60*	mt 15 COD. 543550 € 4,4 - 5,32*	mt 15 COD. 543850 € 5,9 - € 7,14*	-	-	-
mt 15 COD. 542690 € 2,5 - € 3,03*	mt 15 COD. 541140 € 3,0 - € 3,63*	mt 15 COD. 541150 € 3,4 - 4,11*	mt 15 COD. 545260 € 3,8 - € 4,60*	mt 15 COD. 543300 € 4,4 - € 5,32*	mt 15 COD. 543400 € 4,9 - € 5,93*	mt 9 COD. 544380 € 4,5 - € 5,45*	-	-	-
-	mt 130 COD. 541170 € 12,9 - € 15,61*	mt 90 COD. 541200 € 12,5 - € 15,13	mt 70 COD. 545280 € 12,0 - € 14,52*	mt 60 COD. 541210 € 12,9 - 15,61	mt 50 COD. 541900 € 13,0 - € 15,73*	mt 35 COD. 543030 € 13,3 - € 16,09*	-	-	-
mt 100 COD. 542850 € 6,3 - € 7,62*	mt 100 COD. 540800 € 9,5 - € 11,50	mt 100 COD. 540810 € 12,6 - € 15,25*	mt 100 COD. 545300 € 15,0 - € 18,15*	mt 100 COD. 540820 € 18,6 - € 22,51*	mt 100 COD. 541910 € 22,3 - € 26,98*	-	-	-	-
mt 750 COD. 542860 € 23,1 - € 27,95*	mt 520 COD. 540870 € 23,1 - € 27,95*	mt 360 COD. 540880 € 23,1 - € 27,95*	mt 310 COD. 545250 € 23,1 - € 27,95*	mt 240 COD. 540890 € 23,1 - € 27,95*	mt 210 COD. 541880 € 23,1 - € 27,95*	mt 150 COD. 542910 € 23,1 - € 27,95*	COD. 544550 € 23,1 - € 27,95*	COD. 545140 € 23,1 - 27,95*	-
mt 3750 COD. 542860-10K € 20,7 - € 25,05*	mt 2600 COD. 540870-10K € 20,7 - € 25,05*	mt 1800 COD. 540880-10K € 20,7 - € 25,05*	mt 1550 COD. 545250-10K € 20,7 - € 25,05*	mt 1200 COD. 540890-10K € 20,7 - € 25,05*	mt 1050 COD. 541880-10K € 20,7 - € 25,05*	mt 750 COD. 542910-10K € 20,7 - € 25,05*	-	-	-

## SQUARE SHAPE NYLON LINE



	2.4	2.7	3.0	3.3	4.0
mt 15 COD. 542750 € 3,1 - € 3,75*	mt 15 COD. 545220 € 3,5 - € 4,24*	mt 15 COD. 543590 € 4,1 - € 4,96*	mt 15 COD. 543150 € 4,8 - € 5,81*	mt 15 COD. 544340 € 6,9 - € 8,35*	-
mt 15 COD. 542300 € 3,7 - € 4,48*	mt 15 COD. 544190 € 4,0 - € 4,84*	mt 15 COD. 543330 € 4,6 - € 5,57*	mt 15 COD. 544360 € 5,3 - € 6,41*	mt 9 COD. 544370 € 5,2 - € 6,29*	-
mt 60 COD. 542060 € 10,1 - € 12,22*	mt 50 COD. 544110 € 10,1 - € 12,22*	mt 40 COD. 542280 € 10,2 - € 12,34*	mt 40 COD. 542990 € 11,9 - € 14,40*	mt 25 COD. 543960 € 12,1 - 14,64*	-
mt 100 COD. 542360 € 14,1 - € 17,06*	mt 100 COD. 545290 € 16,5 - € 19,97*	mt 100 COD. 542370 € 20,4 - € 24,68*	mt 100 COD. 543000 € 24,8 - € 30,01*	-	-
mt 345 COD. 542320 € 23,1 - € 27,95*	mt 278 COD. 544050 € 23,1 - € 27,95*	mt 232 COD. 542310 € 23,1 - € 27,95*	mt 182 COD. 542920 € 23,1 - € 27,95*	mt 110 COD. 543710 € 23,1 - 27,95*	-
mt 1725 COD. 542320-10K € 20,7 - € 25,05*	mt 1390 COD. 544050-10K € 20,7 - € 25,05*	mt 1160 COD. 542310-10K € 20,7 - € 25,05*	mt 910 COD. 542920-10K € 20,7 - € 25,05*	mt 550 COD. 543710-10K € 20,7 - € 25,05*	-



## STAR SHAPE NYLON LINE



	2.4	3.0	3.3
mt 15 COD. 542770 € 2,6 - € 3,15*	mt 15 COD. 543980 € 3,4 - € 4,11	mt 15 COD. 543530 € 3,9 - € 4,72	-
mt 15 COD. 542210 € 3,2 - € 3,87*	mt 15 COD. 543310 € 3,9 - € 4,72*	mt 15 COD. 544350 € 4,4 - € 5,32	-
mt 90 COD. 542070 € 10,9 - € 13,19	mt 60 COD. 542080 € 11,0 - € 13,31*	mt 50 COD. 542090 € 11,4 - € 13,79*	-

	2.4	3.0	3.3
mt 100 COD. 542240 € 10,7 - € 12,95*	mt 100 COD. 542250 € 15,5 - € 18,76*	mt 100 COD. 542260 € 19 - € 22,99*	-
mt 345 COD. 542330 € 23,1 - € 27,95*	mt 232 COD. 542340 € 23,1 - € 27,95*	mt 182 COD. 542350 € 23,1 - € 27,95*	-
mt 1725 COD. 542380-10K € 20,7 - € 25,05*	mt 1160 COD. 542340-10K € 20,7 - € 25,05*	mt 910 COD. 542350-10K € 20,7 - € 25,05*	-





# BRUSHCUTTERS ACCESSORIES

BRUSHCUTTERS ACCESSORIES

## SILENCED NYLON LINE



2.5	3.0	3.3
mt 86 COD. 545360 € 14,1 - € 17,06*	mt 50 COD. 545370 € 14,1 - € 17,06*	mt 37 COD. 545380 € 14,1 - € 17,06*

## TITANIUM POWER NYLON LINE ROUND SHAPE



2.5	3.0	3.5	4.0
mt 80 COD. 546720 € 16 - € 19,36*	mt 56 COD. 546730 € 16 - € 19,36	mt 41 COD. 546740 € 16 - € 19,36*	mt 29 COD. 547550 € 16 - € 19,36
mt 15 COD. 546690 € 5,6 - € 6,78*	mt 15 COD. 546700 € 6,9 - € 8,35*	mt 15 COD. 546710 € 8,2 - € 9,92*	-
mt 360 COD. 546750 € 28,1 - € 34,00*	mt 240 COD. 546760 € 28,1 - € 34,00	mt 210 COD. 546770 € 28,1 - € 34,00*	mt 150 COD. 548030 € 28,1 - € 34,00*
mt 1800 COD. 546750-10K € 25,7 - € 31,10*	mt 1200 COD. 546760-10K € 25,7 - € 31,10*	mt 1050 COD. 546770-10K € 25,7 - € 31,10*	mt 700 COD. 548030-10K € 25,7 - € 31,10*



## TITANIUM POWER NYLON LINE SQUARE SHAPE



3.0	3.5	4.0
mt 44 COD. 547530 € 17,7 - € 21,42*	mt 32 COD. 546930 € 17,7 - € 21,42*	mt 23 COD. 547540 € 17,7 - € 21,42*
mt 232 COD. 548000 € 28,1 - € 34,00*	mt 182 COD. 548010 € 28,1 - € 34,00*	mt 110 COD. 548020 € 28,1 - € 34,00*
mt 1060 COD. 548000-10K € 25,7 - € 31,10	mt 780 COD. 548010-10K € 25,7 - € 31,10*	mt 590 COD. 548020-10K € 25,7 - € 31,10*



## NYLSAW NYLON LINE

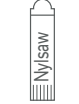

3.0	3.5	4.0	4.5
mt 37 COD. 544740 € 19,3 - € 23,35*	mt 27 COD. 544750 € 19,3 - € 23,35*	mt 21 COD. 544760 € 19,3 - € 23,35*	mt 16 COD. 544770 € 19,3 - € 23,35*
35 fili COD. 545090 € 10,6 - € 12,83*	25 fili COD. 545100 € 10,6 - € 12,83*	20 fili COD. 545110 € 10,6 - € 12,83*	15 fili COD. 545120 € 10,6 - € 12,83*



## WAVY LINE



T 2 - SP66	T.2,4 - SP66	T.2,7 - SP66	T.3 - SP66
mt 126 548190 €	mt 87 548200 €	mt 72 548210 €	mt 56 548220 €





## HEDGE TRIMMERS



- The edge trimmer is a tool designed for cutting hedges as easily as possible.
- Suitable for carrying out pruning activities without difficulty even on the sturdiest hedges.
- Consisting essentially of 3 elements: motor, handle, double cut blade in stainless steel.
- High quality blades guarantee a clean cut.
- The product is easy to use thanks to the adjustable handle to give the operator the possibility to always cut with maximum comfort.



01. Adjustable handle

02. Hand protection

03. Cutting tooth

04. Blades



**01. Adjustable ergonomic handle** for easier handling and comfort.

**02. Hand protection:** the handle placed close to the blade has the function of protecting the hands of the user.

**03.** The **teeth** are milled and can cut very thick branches.

**04. Double blades** with double movement cutting bars to ensure maximum precision.





## HTE 600

**COD. 880110**

Electric engine	600W 230V - 50HZ
Blade length	51 cm
Blade type	Double guided cutting bars
Teeth	On both sides
Tooth pitch	24 mm
Adjustable handle	no
Weight	3.2 kg
<b>Retail price</b>	<b>€ 85 - € 102,85*</b>



HEDGE TRIMMERS

## HTE 710

**COD. 880120**

Electric engine	710W 230V - 50HZ
Blade length	61 cm
Blade type	SK steel double guided cutting bars
Teeth	On both sides
Tooth pitch	24 mm
Adjustable handle	On 5 positions at 180°
Weight	3.7 kg
<b>Retail price</b>	<b>€ 105 - € 127,05*</b>



## HT 261

**COD. 881610**

Engine	1E34FN - 2-stroke* - 25.4 cc
Power	0.6 kW/7000 rpm
Blade length	61 cm
Blade type	Double guided cutting bars
Teeth	On both sides
Tooth pitch	27 mm
Blade break	Included
Adjustable handle	On 5 positions at 180°
Weight**	6.3 kg
<b>Retail price</b>	<b>€ 205 - € 248,05</b>



\* 2% synthetic oil mixture  
\*\* Weight without mixture



## HT 261-J60

### COD. 883260A

Engine	1E34FN - 2-stroke* - 25.4 cc
Power	0.7 kW/7000 rpm
Blade length	60 cm
Blade type	Double guided cutting bars
Teeth	On both sides
Tooth pitch	28 mm
Adjustable handle	On 5 positions at 180°
Weight**	5.2 kg
<b>Retail price</b>	<b>€ 395 - € 477,95*</b>



\* 2% synthetic oil mixture  
\*\* Weight without mixture

## HTK 230-J60

### COD. 883180A

Engine Kawasaki	TJ 23 V - 2-stroke* - 23.3 cc
Power	0.63 kW/7500 rpm
Blade length	60 cm
Blade type	Double guided cutting bars
Teeth	On both sides
Tooth pitch	28 mm
Adjustable handle	On 5 positions at 180°
Weight**	5.4 kg
<b>Retail price</b>	<b>€ 545 - € 659,45*</b>



\* 2% synthetic oil mixture  
\*\* Weight without mixture

## HT 261-J75

### COD. 885750A

Engine	1E34FN - 2-stroke* - 25.4 cc
Power	0.7 kW/7000 rpm
Blade length	75 cm
Blade type	Double guided cutting bars
Teeth	On both sides
Tooth pitch	28 mm
Adjustable handle	On 5 positions at 180°
Weight**	5.4 kg
<b>Retail price</b>	<b>€ 410 - € 496,10*</b>



\* 2% synthetic oil mixture  
\*\* Weight without mixture





# HTK 230-J75



HEDGE TRIMMERS

**COD. 885130A**

Engine Kawasaki	TJ 23 V - 2-stroke* - 23.3 cc
Power	0.63 kW/7500 rpm
Blade length	75 cm
Blade type	Double guided cutting bars
Teeth	On both sides
Tooth pitch	28 mm
Adjustable handle	On 5 positions at 180°
Weight**	5.6 kg
<b>Retail price</b>	<b>€ 570 - € 689,70*</b>



\* Miscela 2% con olio sintetico  
\*\* Weight senza miscela





## BLOWERS / SPRAYERS



- Blowers and vacuums ideal for clearing or collecting fallen leaves effortlessly.
- The vacuum function shreds the foliage optimizing the space in the bag, returning the material ready for composting.
- Sprayers for the maintenance of fruit and vegetable plants, suitable for all types of treatment thanks to the nebulization and pulverization function.



- 01. Handle** with vibration dampers for greater comfort.
- 02. Easy starting** that allows the machine to be started without effort and fatigue.

- 03. Lower handle** for conversion to aspirator.
- 04. Outlet pipe** aligned with the engine.



## BLV 281



*Blower and vacuum  
in one tool*

**COD. 883740**

Engine	Ecological Euro 5 2 stroke*
Displacement	27.2 cc
Collecting bag	45 lt
Air emission speed	252 km/h
Shredding ratio	10:1
Weight vacuum/ blower**	5.7 / 4.6 kg
<b>blower **</b>	<b>€ 205 - € 248,05*</b>



\* 2% synthetic oil mixture  
\*\* Weight without mixture

BLOWERS - SPRAYERS

## BBL 801

**COD. 883890**

Engine	Ecologico Euro 5 a scoppio 2-stroke*
Displacement	75.6 cc
Air emission speed	331 km/h
Cruise control	included
Weight **	11.6 kg
<b>Retail price</b>	<b>€ 500 - € 605,00*</b>



\* 2% synthetic oil mixture  
\*\* Weight without mixture

## MD 601

## SPRAYER

**COD. 880350**

Engine	Ecological Euro 5 2-stroke*
Displacement	59.2 cc
Power	2.65 kW
Tank capacity	14 lt
Max range	8 mt
Max range with double tip (included)	12 mt
Suitable for	Liquid and dust
Pump	included
Weight*	10.3 kg
<b>Retail price</b>	<b>€ 310 - € 375,10*</b>





## LAWN MOWERS / SCARIFIERS



- The wide range of lawnmowers offered by Blue Bird Industries is able to satisfy the most varied needs of both the amateur and professional user.
- We find models which, thanks to their lightness and manageability, are ideal for the home garden and for surfaces up to 500 metres.
- The self-propelled lawn mowers, with steel or aluminum decks, guarantee great reliability and cutting quality in all situations and with surfaces up to 3000 metres.
- All models are equipped with Cutting height adjustment and grass catcher.
- The super professional models are equipped with a three-speed gearbox.



**01. Steel deck** for greater resistance.

**02. Side discharge deflector:** for an effective redistribution of the grass on the lawn.

**03. Accelerator lever** to customize the mower's cutting speed.

**04. Centralized height adjustment** that allows you to quickly select the desired grass height by choosing from the available positions.



## SPRINT B42

**COD. 885660**

Engine BBI	146 cc
Cutting width	42 cm
Cutting height	5 pos. from 2.5 to 7.5 cm
Cutting height adjustment	Central
Wheels size	front 6" - back 7"
Deck	metal
Grass collecting bag	40 lt
Traction	no
Net weight	23 kg
<b>Retail price</b>	<b>€ 245 - € 296,45*</b>



LAWN MOWERS

## SPRINT B46 T

**COD. 885670**

Engine BBI	146 cc
Cutting width	46 cm
Cutting height	7 pos. from 2.5 to 7.5 cm
Cutting height adjustment	Central
Wheels size	front 7" - back 8"
Deck	metal
Grass collecting bag	50 lt
Traction	yes
Included Accessories	Mulching kit - side discharge
Net weight	30 kg
<b>Retail price</b>	<b>€ 320 - € 387,20*</b>





## SPRINT H46 T

**COD. 885690**

Engine Honda	GCVx170 - 166 cc
Cutting width	46 cm
Cutting height	7 pos. from 2.5 to 7.5 cm
Cutting height adjustment	Central
Wheels size	front 7" - back 8"
Deck	metal
Grass collecting bag	50 lt
Traction	yes
Accessories included	Mulching kit - side discharge
Net weight	30 kg
<b>Retail price</b>	<b>€ 600 - € 726,00*</b>



## SPRINT B51 T

**COD. 885680**

Engine BBI	173 cc
Cutting width	51 cm
Cutting height	7 pos. from 2.5 to 7.5 cm
Cutting height adjustment	Central
Wheels size	front 7" - back 8"
Deck	metal
Grass collecting bag	60 lt
Traction	yes
Accessories included	Mulching kit - side discharge
Net weight	39 kg
<b>Retail price</b>	<b>€ 375 - 453,75*</b>



## SPRINT H51 T

**COD. 885700**

Engine Honda	GCVx200 - 201 cc
Cutting width	51 cm
Cutting height	7 pos. from 2.5 to 7.5 cm
Cutting height adjustment	Central
Wheels size	front 7" - back 10"
Deck	metal
Grass collecting bag	60 lt
Traction	yes
Accessories included	Mulching kit - side discharge
Net weight	39 kg
<b>Retail price</b>	<b>€ 610 - € 738,10*</b>







## TAURUS L41

**COD. 885760**

Engine	Loncin 123 cc
Cutting width	41 cm
Cutting height	6 pos. from 2.5 to 7.5 cm
Cutting height adjustment	Central
Deck	High quality steel
Grass collecting bag	45 lt
Traction	no
Net weight	23 kg
<b>Retail price</b>	<b>€ 275 - € 332,75*</b>

**LAWN MOWERS**

## TAURUS L46

**COD. 887440**

Engine	Loncin 166 cc
Cutting width	46 cm
Cutting height	6 pos. from 2.5 to 7.5 cm
Cutting height adjustment	Central
Deck	High quality steel
Grass collecting bag	45 lt
Traction	no
Net weight	29 kg
<b>Retail price</b>	<b>€ 310 - € 375,10*</b>

## TAURUS L46 T

**COD. 885620**

Engine	Loncin 139 cc
Cutting width	46 cm
Cutting height	6 pos. from 2.5 to 7.5 cm
Cutting height adjustment	Central
Deck	High quality steel
Grass collecting bag	60 lt
Traction	yes
Accessories included	Mulching kit - side discharge
Net weight	33 kg
<b>Retail price</b>	<b>€ 350 - € 423,50*</b>





## TAURUS L46 TWS / TAURUS H46 TWS

	<b>COD. 885530</b>	<b>COD. 885540</b>
Engine	Loncin - 159 cc	Honda GCV170 - 166 cc
Cutting width	46 cm	46 cm
Cutting height	6 pos. from 2.5 to 7.5 cm	6 pos. from 2.5 to 7.5 cm
Cutting height adjustment	Central	Central
Deck	High quality steel	High quality steel
Grass collecting bag	60 lt	60 lt
Traction	yes	yes
Accessories included	Mulching kit - side discharge	Mulching kit - side discharge
Net weight	33 kg	33 kg
<b>Retail price</b>	<b>€ 470 - € 568,70*</b>	<b>€ 625 - 756,25*</b>



## TAURUS L51 T / TAURUS L51 TI

	<b>COD. 885630</b>	<b>COD. 885640</b>
Engine	Loncin 196 cc	Loncin Instart - 196 cc
Cutting width	51 cm	51 cm
Cutting height	6 pos. from 2.5 to 7.5 cm	6 pos. from 2.5 to 7.5 cm
Cutting height adjustment	Central	Central
Deck	High quality steel	High quality steel
Grass collecting bag	65 lt	65 lt
Traction	yes	yes
Accessories included	Mulching kit - side discharge	Mulching kit - side discharge
Net weight	35 kg	35 kg
<b>Retail price</b>	<b>€ 385 - € 465,85*</b>	<b>€ 475 - € 574,75*</b>



## TAURUS L51 TWS / TAURUS H51 TWS

	<b>COD. 885550</b>	<b>COD. 885560</b>
Engine	Loncin - 196 cc	Honda GCVx200 - 201 cc
Cutting width	51 cm	51 cm
Cutting height	6 pos. from 2.5 to 7.5 cm	6 pos. from 2.5 to 7.5 cm
Cutting height adjustment	Central	Central
Deck	High quality steel	High quality steel
Grass collecting bag	70 lt	70 lt
Traction	yes	yes
Accessories included	Mulching kit - side discharge	Mulching kit - side discharge
Net weight	47 kg	47 kg
<b>Retail price</b>	<b>€ 520 - € 629,20*</b>	<b>€ 690 - € 834,90*</b>





## TAURUS L56 TW

**COD. 885570**

Engine	Loncin 196 cc
Cutting width	56 cm
Cutting height	Adjustable on 5 from 3 to 7.5 cm
Cutting height adjustment	Central
Deck	High quality steel
Grass collecting bag	75 lt
Traction	yes - 4 Speed
Accessories included	Mulching kit - side discharge
Net weight	47 kg
<b>Retail price</b>	<b>€ 540 - € 653,40*</b>



LAWN MOWERS

## TAURUS BS53 TWA

**COD. 879040**

Engine	B&S serie 675 EXI - 163 cc
Cutting width	53 cm
Cutting height	Adjustable on 7 positions da 2.5 a 8 cm
Cutting height adjustment	Central
Deck	aluminium
Grass collecting bag	70 lt
Traction	yes
Accessories included	mulching kit
Net weight	45 kg
<b>Retail price</b>	<b>€ 790 - € 955,90*</b>



## TAURUS K51 PRO

**COD. 885580**

Engine Kawasaki	FJ180V - 179 cc
Cutting width	51 cm
Cutting height	Adjustable on 6 positions da 3 a 9 cm
Cutting height adjustment	Central
Deck	High quality steel
Grass collecting bag	70 lt
Traction	yes - 1 Speed
Accessories included	Mulching kit - side discharge
Net weight	47 kg
<b>Retail price</b>	<b>€ 775 - € 937,75*</b>





## LAWN MOWERS ACCESSORIES

### LAME

Mulching blade for mod. Taurus 51T e World WYZ20-BS60-B	<b>COD. 20000028</b>	<b>€ 20,39*</b>
Mulching blade for mod. Taurus 56TW e World WYZ22-BS60-B	<b>COD. 22000398</b>	<b>€ 22,65*</b>
Blade for Taurus/World lawn mower cutting width 41 cm	<b>COD. 1600119</b>	<b>€ 17,37*</b>
Blade for Taurus/World lawn mower cutting width 46 cm	<b>COD. XSS46-01</b>	<b>€ 18,12*</b>
Blade for Taurus/World lawn mower cutting width 51 cm	<b>COD. 20000002</b>	<b>€ 19,63*</b>
Blade for Taurus/World lawn mower 53T	<b>COD. 21000005</b>	<b>€ 24,16*</b>
Blade for Taurus/World lawn mower 53TW	<b>COD. 2100709</b>	<b>€ 22,65*</b>
Blade for Taurus/World lawn mower cutting width 56 cm	<b>COD. 22000039</b>	<b>€ 24,16*</b>







# TAURUS BS51 S

## SCARIFIER



LAWN MOWERS -

**COD. 885590**

Engine	B&S XR 750
Working width	51 cm
Cutting height	5 positions
Cutting height adjustment	Central
Deck	High quality steel
Cutting system	Straight blades
Net weight	45 kg
<b>Retail price</b>	<b>€ 720 - € 871,20*</b>







## LAWN TRACTORS / RIDER



- These are exceptional tools for landscaping suitable for both users who want to keep their garden tidy, and for professionals who want to take care of large parks and green areas.
- The models are available with two discharge modes: rear and side complete with mulching option. For all models the cutting height is adjustable in 7 different positions and the plate is made of steel.
- The machines are equipped with hydrostatic and mechanical transmission.



**01. Led headlights** for wide visibility.

**02. Comfortable seat to work in comfort.**

**03. Steel plate** for greater strength.

**04. Starting electric motor.**

**05. Hydrostatic transmission** for complete pedal speedcontrol.





## LT SD 86M



### COD. 888520

Cutting mode	Side discharge+mulching
Cutting width	86 cm
Cutting deck	Steel
Cutting height	30-90 mm (7 positions)
Engine	Loncin 352
Starting	Electric
Fuel tank	7,5 lt
Trasmission	Mechanical
Headlights	yes
Seat	Adjustable
Weight	170 kg
<b>Retail price</b>	<b>€ 2.388,43 - € 2.890,00*</b>



TRATTORIN / RIDER

## LT SD 98M / LT SD 98H



### COD. 888540

### COD. 888240

Cutting mode	Side discharge+mulching	Side discharge+mulching
Cutting width	98 cm	98 cm
Cutting deck	Steel	Steel
Cutting height	30-90 mm (7 positions)	30-90 mm (7 positions)
Engine	Loncin 432	Loncin 432
Starting	Electric	Electric
Fuel tank	7,5 lt	7,5 lt
Trasmission	Mechanical	Hydro
Headlights	yes	yes
Seat	Adjustable	Adjustable
Weight	190 kg	190 kg
<b>Retail price</b>	<b>€ 2.475,21 - €2.995*</b>	<b>€ 2.764,46 - 3.345*</b>



## LT SD 108H

### COD. 888100

Cutting mode	Side discharge+mulching
Cutting width	108 cm
Cutting deck	Steel
Cutting height	30-90 mm (7 positions)
Engine	Loncin 452
Starting	Electric
Fuel tank	7,5 lt
Trasmission	Hydro
Headlights	yes
Seat	Adjustable
Weight	170 kg
<b>Retail price</b>	<b>€ 2.929,75 - € 3.545*</b>





## LT C 86M / LT C 86H

	<b>COD. 888530</b>	<b>COD. 888130</b>
Cutting mode	Back discharge + mulching	Back discharge + mulching
Cutting width	86 cm	86 cm
Cutting deck	Steel	Steel
Cutting height	30-90 mm (7 positions)	30-90 mm (7 positions)
Engine	Loncin 432	Loncin 432
Starting	Electric	Electric
Fuel tank	7,5 lt	7,5 lt
Trasmission	Mechanical	Hydro
Grass collector capacity	245 lt	245 lt
Headlights	yes	yess
Seat	Adjustable	Adjustable
Weight	190 kg	190 kg
<b>Retail price</b>	<b>€2.966,94 - € 3.590*</b>	<b>€ 3.098,35 - € 3.749*</b>



## LT C 92H

	<b>COD. 888110</b>
Cutting mode	Back discharge + mulching
Cutting width	92 cm
Cutting deck	Steel
Cutting height	30-90 mm (7 positions)
Engine	Loncin 452
Starting	Electric
Fuel tank	7,5 lt
Trasmission	Hydro
Grass collector capacity	245 lt
Headlights	yes
Seat	Adjustable
Weight	210 kg
<b>Retail price</b>	<b>€ 3.297,52 - € 3.990*</b>



## LT C 102H TWIN

	<b>COD. 888120</b>
Cutting mode	<b>Rear discharge + mulching</b>
Cutting width	102 cm
Cutting deck	Steel
Cutting height	30-90 mm (7 positions)
Engine	Loncin 586 TWIN
Starting	Electric
Fuel tank	7,5 lt
Trasmission	Hydro
Grass collector capacity	245 lt
Headlights	yes
Seat	Adjustable
Weight	210 kg
<b>Retail price</b>	<b>€ 3.876,03 - € 4.690*</b>



All lawn tractors models by Blue Bird Industries are supplied with a maintained battery charger





## RIDER BR SD 98



**COD. 888550**

Battery	48 V - 75 Ah <b>included</b>
Engine Power	1200 W
Blades Power	1350 W
Cutting width	98 cm
Cutting height	30-100 mm (7 positions)
Turning radius	45 cm
Cutting mode	Side discharge+mulching
Drive	Pedal operated
Maximum Speed	12,8 km/h
<b>Retail price</b>	<b>€ 3.793,39 - € 4.590*</b>



LAWN TRACTORS / RIDER

## RIDER BR SD 108



**COD. 888560**

Battery	48 V - 75 Ah <b>included</b>
Power Engine avanzamento	1200 W
Power Engine lame	1350 W
Cutting width	108 cm
Cutting height	30-100 mm (7 positions)
Turning radius	45 cm
Cutting mode	Side discharge+mulching
Drive	Pedal operated
Maximum Speed	12,8 km/h
<b>Retail price</b>	<b>€ 4.049,59 - € 4.900*</b>





## LARGE SURFACE MOWERS



- A new range allows easy lawn mowing while working quickly and with great results.
- Machines for professional use suitable for large surfaces such as parks or public gardens.
- The innovative, robust and stable structure allows practical and intuitive driving, ideal for terrains with obstacles that need to be circumvented with greater manoeuvrability.
- Pneumatic wheels are ideal for large uneven ground.



**01. Comfortable seat** to face hours of work in comfort.

**02. "Turf care"** rear wheels to adapt perfectly to the ground.

**03. Cutting plate** in welded steel sheet, robust, equipped with 3 blades. Made to tackle taller, denser grass with ease.

**04. "Easy lift"** deck lift pedal.

**05. Led lights** for a wide visibility.



## LM 715 PRO

**COD. 882470**

Engine	Briggs & Stratton - 344 cc
Power	10.5 Hp
Cylinders	1
Trasmission	3 Speed
Cutting mode	Side discharge
Cutting width	711 mm
Cutting height	6 positions
Speed	3 forward Speeds
Weight	154 kg
<b>Retail price</b>	<b>€ 2.230 - € 2.698,30</b>



## ZTR 46 L PRO

**COD. 882560**

Engine	Loncin LC2P77 - 708 cc
Power	16 kW
Cylinders	2
Trasmission	Hydro
Blades engagement	Electromagnetic clutch
Cutting mode	Mulching kit - side discharge
Cutting width	1160 mm
Cutting height	7 positions
Speed	1 forward Speeds + reverse
Included Accessories	LED headlights
Weight	270 kg
<b>Retail price</b>	<b>€ 6.400 - € 7.744,00*</b>





## ZTR 50 PRO

**COD. 882480**

Engine	Kawasaki FR691V - 726 cc
Power	15.4 kW (20.6 h6) / 3600 rpm
Cylinders	2
Trasmission	Hydro
Blades engagement	Electromagnetic clutch
Cutting mode	Mulching kit - side discharge
Cutting width	1270 mm
Cutting height	7 positions
Speed	1 forward speed + reverse
Accessories included	Roll-bar - LED headlights
Weight	270 kg
<b>Retail price</b>	<b>€ 7.100 - € 8.591,00*</b>

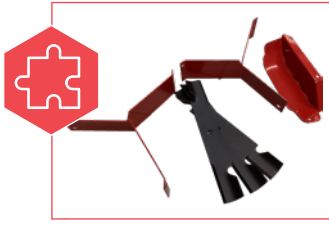

**OPTIONAL MULCHING KIT**  
46"/50"

**COD. 733140** € 211,75\*



## ZTR 50 L PRO

**COD. 882490**

Engine	Loncin LC2P77F - 708 cc
Power	16 kW (3600 g/m SAE)
Cylinders	2
Trasmission	Hydro
Blades engagement	Electromagnetic clutch
Cutting mode	Mulching kit - side discharge
Cutting width	1270 mm
Cutting height	7 positions
Speed	1 forward speed + reverse
Accessories included	Roll-bar - LED headlights
Weight	270 kg
<b>Retail price</b>	<b>€ 6.600 - 7.986,00*</b>



**OPTIONAL MULCHING KIT**  
46"/50"

**COD. 733140** € 211,75\*

*Ready for  
large areas*







# ZTR 60 K PRO



**COD. 884660**

Engine	Kawasaki FX730V - 726cc/23.5hp
Trasmission	Hydro
Starting	Electric
Cutting mode	Mulching kit - side discharge
Cutting height	1.5" - 4.75" / 13 positions
Cutting diameter	60" / 1524mm
Blades	3
Forward speed	16 kmh
Reverse speed	9 kmh
Front wheels	13 - 6.50 x 6
Back wheels	23 - 10.5 x 12
Fuel tank	60L
Pack size	2088*1446/865 mm
Seat	Deluxe suspension with support
Net weight	463 kg
<b>Retail price</b>	<b>€ 12.300 - 14.883,00*</b>



LARGE SURFACE MOWERS



**OPTIONAL MULCHING KIT  
60"**

**COD. 733340 € 211,75\***

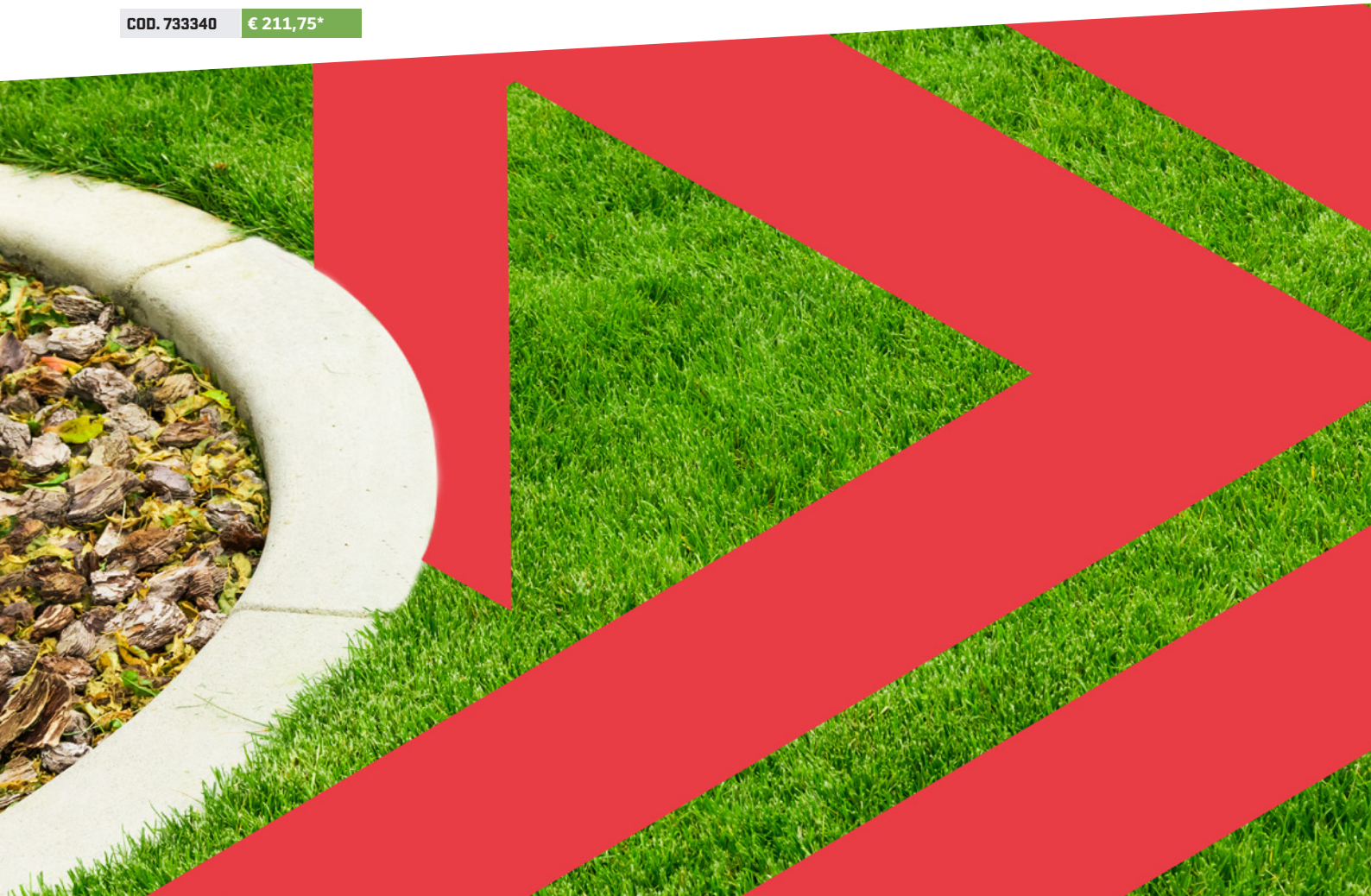





## WHEELED BRUSHCUTTERS



- Wheeled brushcutters are machines particularly suitable for large surfaces, with very tall grass and in the presence of scrub.
- Designed for mowing inaccessible and hilly areas, they can be an effective alternative to straight shaft or backpack brushcutters.
- These machines offer a wide range of cutting applications that meet all user needs.
- The blade application ensures a cut with a high degree of shredding of the grass.



Blue Bird Industries offers models equipped with large wheels that make the machine extremely agile and easy to handle or models with small wheels and deep grooves that guarantee exceptional traction, even on particularly uneven terrain and steep slopes.

- 01. Adjustable bars** for comfort during use
- 02. Accelerator lever** that allows you to choose from the available Speeds
- 03. New belt protection cover** for greater strength and safety.
- 04. Nylon line cutting tool** for optimal shredding.
- 05. Wheels 16"** for exceptional traction







# FLO 6 / FLO 7



FLO 6



FLO 7

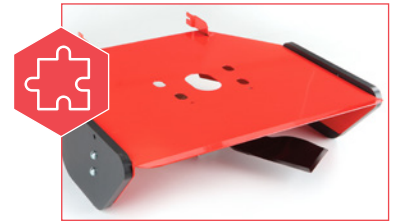

**OPTIONAL BLADE**  
APPLICATION FLO BLADE

Ø 53 cm    COD. 730180    € 260,15\*

WHEELED BRUSHCUTTERS

	<b>SPEED 6 LC</b> COD. 882090	<b>SPEED 6 HO</b> COD. 885350	<b>PRO SPEED 6 HO</b> COD. 885330
Engine	Loncin - 4 stroke	Honda GCV 170 - 4 stroke	Honda GCVx200 - 4 stroke
Displacement	196 cc	166 cc	201 cc
Torque (Nm) Power (Kw)	12.4 Nm/2500 rpm	11.1 Nm/2500 rpm	12.7 Nm/2500 rpm
Cutting system	Nylon line (optional blade application)	Nylon line (optional blade application)	Nylon line (optional blade application)
Speeds	3 forward speeds	3 forward speeds	3 forward speeds
Wheels	Alloy	Alloy	Alloy
<b>Retail price</b>	<b>€ 1.320 - € 1.597,20*</b>	<b>€ 1.410 - € 1.706,10*</b>	<b>€ 1.475 - € 1.784,75*</b>

	<b>SPEED 7 LC</b> COD. 882510	<b>SPEED 7 HO</b> COD. 882540	<b>PRO SPEED 7 HO</b> COD. 882550
Engine	Loncin - 4 stroke	Honda GCV 170 - 4 stroke	Honda GCVx200 - 4 stroke
Displacement	196 cc	166 cc	201 cc
Torque (Nm) Power (Kw)	12.4 Nm/2500 rpm	11.1 Nm/2500 rpm	12.7 Nm/2500 rpm
Cutting system	Nylon line (optional blade application)	Nylon line (optional blade application)	Nylon line (optional blade application)
Speeds	3 forward speeds	3 forward speeds	3 forward speeds
Wheels	Alloy	Alloy	Alloy
<b>Retail price</b>	<b>€ 1.410 - € 1706,10*</b>	<b>€ 1.495 - € 1.808,95*</b>	<b>€ 1.565 - € 1.893,65*</b>



*Guaranteed  
mowing*







# DOMINO



WHEELED BRUSHCUTTERS



**DOMINO BLADE**  
BLADE APPLICATION

Ø 53 cm **COD. 729160** € 350,90\*



**DOMINO THREAD**  
THREAD APPLICATION

Ø 60 cm **COD. 726330** € 108,90\*

	<b>DOMINO TS LC</b> <b>COD. 882290</b>	<b>DOMINO TS PRO/LC</b> <b>COD. 882300</b>	<b>DOMINO TS PRO/H</b> <b>COD. 885290</b>
Engine	Loncin - 4 stroke	Loncin - 4 stroke	Honda GCVx200 - 4 stroke
Displacement	196 cc	196 cc	201 cc
Torque (Nm) Power (Kw)	12.4 Nm/2500 rpm	12.4 Nm/2500 rpm	12.7 Nm/2500 rpm
Cutting system	Nylon line or blade (according to application)	Nylon line or blade (according to application)	Nylon line or blade (according to application)
Cutting width	Nylon line or blade (according to application)	Nylon line or blade (according to application)	Nylon line or blade (according to application)
Speeds	1 forward speed	3 forward speeds + reverse	3 forward speeds + reverse
Blade clutch brake	yes	yes	Yes + wheels brake
Wheels	Pneumatic	Pneumatic	Pneumatic
Weight	63.9 kg	64.5 kg	65.4 kg
<b>Retail price</b>	<b>€ 1.600 - € 1.936,00*</b>	<b>€ 1.665 - 2.014,65*</b>	<b>€ 1.885 - € 2.280,85*</b>



# ALHAMBRA TS / ALHAMBRA TS PRO



ALHAMBRA TS



ALHAMBRA TS PRO

**ADJUSTABLE  
GRASS GUARD**

 da 0 a 40 cm **COD. 727560** € 59,25\*

	<b>ALHAMBRA TS LC COD. 882310</b>	<b>ALHAMBRA TS 170 HO COD. 881770</b>
Engine	Loncin - 4 stroke	Honda GCV170 - 4 stroke
Displacement	196 cc	166 cc
Torque (Nm) Power (Kw)	12.4 Nm/2500 rpm	11.1 Nm/2500 rpm
Cutting system	With retractable blades	With retractable blades
Cutting width	60 mm	60 mm
Speeds	1 forward speed	1 forward speed
Blade clutch brake	yes	yes
Wheels	Full	Full
Weight	73.5 kg	74.1 kg
<b>Retail price</b>	<b>€ 1.675 - € 2.026,75*</b>	<b>€ 1.765 - € 2.135,65*</b>

	<b>ALHAMBRA TS PRO LC COD. 882320</b>	<b>ALHAMBRA TS PRO 170 HO COD. 887470</b>
Engine	Loncin - 4 stroke	Honda GCV170 - 4 stroke
Displacement	196 cc	166 cc
Torque (Nm) Power (Kw)	12.4 Nm/2500 rpm	11.1 Nm/2500 rpm
Cutting system	With retractable blades	With retractable blades
Cutting width	60 mm	60 mm
Speeds	3 forward speeds + reverse	3 forward speeds + reverse
Blade clutch brake	yes	yes
Wheels	Full	Full
Weight	74.6 kg	77.6 kg
<b>Retail price</b>	<b>€ 1.775 - € 2.147,75</b>	<b>€ 1.955 - € 2.365,55</b>





# *Impeccable lawn, unstoppable brushcutter*



WHEELED BRUSHCUTTERS







## REMOTE CONTROL



- The range is suitable for demanding mowing and removal of tall and consistent herbs, cleaning in the undergrowth or near ditches.
- Featuring excellent maneuverability and improved climbing ability on sloping terrain thanks to revolutionary design.
- Grass, brushwood and brambles are easily ground.
- All functions of the machine can be set by means of a radio remote control from a distance up to 200 mt.



## FM 23 - 53

Cod. 887810

Maximum voltage	28 V
Power	600 W
Engine	Loncin 224 cc
Blades size	21 Inchm 53 cm
Speeds	3
Rem contr band	2,4 g
Max comm distance	~200 m
Net weight	126 kg



**01. LED headlights:** for better visibility during use.

**02. Retractable blades:** longer life even in presence of woody shrubs or stones.

**03. Tracks:** suitable for the most difficult or slippery ground

**04. Cutting height:** Remotely adjustable from 3 to 6 cm

**05. STOP switch:** for emergency stop

Retail price

€ 4.700 - € 5.687,00





# FM 23-70



BATTERY  
28 V



- Hybrid system : Engine 452 cc 13,5 hp to ensure maximum power during cutting. 28V battery engine for efficient feed of the track drive. Oil pump for continued mowing on slopes of 30 degrees, maximum 45 degrees.
- **Or 100% electric**, battery drive 50 Ah or 100 Ah
- Standard radio remote control

*Unstoppable  
Power*

REMOTE CONTROL

## FM23-70H

Maximum voltage	28 V
Power	800 W
Engine	Loncin <b>452 cc</b>
Blades size	<b>30 inch (750 mm)</b>
Speed	47 m/min
Remote control band	2.4 g
Max communication distance	About 200 m
Net weight	<b>230 kg</b>
<b>Retail price</b>	
FM23-70H Benzine 13.5pk	€ 5.200 - € 6.292*
FM23-70-50Ah 100% electric	€ 6.500 - € 7.865*
FM23-70-100Ah 100% electric	€ 7.950 - € 9.619*







# FLAIL MOWERS



- The range is suitable for demanding operations of mowing and removal of tall and consistent grasses, cleaning in the undergrowth or near ditches.
- Excellent maneuverability and better climbing ability on slopes thanks to the revolutionary design.
- Self-propelled machines with different cutting heights, in order to satisfy the most demanding users.
- Grass, brushwood and brambles are ground simply.



- 01. Engine:** Loncin 4 stroke with oil bath air filter
- 02. Cutting width:** 86 cm for increased productivity
- 03. Cutting height:** Adjustable millimetrically

- 04. Tracks:** wide footprint for better grip in trend
- 05. Handlebar:** adjustable for better ergonomics





## FM 600



### COD. 883190

Engine	Loncin - 4 stroke - 252 cc
Torque	15 Nm / 2800 rpm
Power	5.2 kW / 3600 rpm
Cutting width	60 cm
Number of knives	32
Trasmission	3 forward speeds - 1 reverse
Turning radius	less than 1.2 mt
Dimensions	180 x 73 x 115
Weight**	145 kg
<b>Retail price</b>	<b>€ 2.700 - 3.267,00*</b>



## FM 750

### COD. 883200

Engine	Loncin - 4 stroke - 420 cc
Power	9.2 kW / 3600 rpm
Cutting width	75 cm
Number of knives	40
Trasmission	3 forward speeds - 1 reverse
Turning radius	less than 1.2 mt
Dimensions	187 x 89 x 130
Weight**	178 kg
<b>Retail price</b>	<b>€ 3.500 - € 4.235,00*</b>



## FM 860

### COD. 888320

Engine	Loncin - 4 stroke - 420 cc
Power	13 HP
Cutting width	86 cm
Number of knives	48
Cutting height	20-150 mm
Trasmission	3 forward speeds - 1 reverse
Efficiency	2500m <sup>2</sup> per hour
Turning radius	less than 1.2 mt
Weight**	285 kg
<b>Retail price</b>	<b>€ 4.860 - € 5.880,60*</b>





## EVEN THE ENVIRONMENT THANKS

A well-maintained wood, besides being pleasant to look at, is a safeguard for the environment. Both tree cutting and limbing are done in order to preserve the wood and obtain useful timber for multiple purposes.

Blue Bird products enable operators to apply the best technique and achieve excellent results by controlling power and cutting.

Relying on the right tools means finding the perfect allies for your work. Blue Bird chainsaws, pruners, log splitters are extremely handy, sturdy and safe.

Thanks to portable winches, you can clear the ground of logs either by towing or moving thanks to the quick hitch.





## HIGHER QUALITY

For forestry work, Blue Bird offers a special line of machinery to be able to intervene quickly and decisively in felling, limbing and handling of branches and logs to be hauled or moved. Products listed in the wood category are designed to act safely, in often inaccessible places, with maximum efficiency.

*When goals  
are high*

## WOOD

Chainsaws / Pruner	PAG 90
Winches	PAG 98
Log Splitters	PAG 100
Shredders	PAG 104
Wood Chippers	PAG 106
Saw Benches	PAG 110



## CHAINSAWS / PRUNER



- Ideal range for each specific skill: from felling, to pruning, to limbing.
- Compact cutting tools designed to be reliable, easy to use and efficient.
- The available models range from 25 to 54 cc displacement, with bars from 25 to 50 cm.



**01. 10" 3/8 bar** for greater precision.

**02. Double-ended brake** to ensure safety during use.

**03. "Always on" button** to assist the user in the ignition phase.

**04. Internal clutch** which guarantees greater engine strength.

**05. Steel anti-vibration** mounts that reduce vibrations and noise.

**06. 3/8 mini chain.**



## CSE 2000

**COD. 881860**

Power	2000 W
Bar length and chain	16" (40 cm) OREGON
Chain lubrication	Automatic
Chain adjustment	tool-less
<b>Retail price</b>	<b>€ 120 - € 145,20*</b>



## CS 250

**COD. 880550**

Displacement	25.4 cc
Power	0.7 kW
Bar length	standard 10" (25 cm)
Chain brake	yes
Chain lubrication	Automatic
Handle	Anti-vibration
Chain code	SE3L-40DL
Bar code	S10E3PP40
Weight*	3.2 kg
<b>Retail price</b>	<b>€ 145 - 175,45*</b>



\* Weight without mixture, bar and chain

## CS 250 C

**COD. 881280**

Displacement	25.4 cc
Power	0.7 kW
Bar length	carving 10" (25 cm)
Chain brake	yes
Chain lubrication	Automatic
Handle	Anti-vibration
Chain code	S25-60DL
Bar code	CSP280TC-BAR
Weight*	3.2 kg
<b>Retail price</b>	<b>€ 170 - € 205,70*</b>



\* Weight without mixture, bar and chain



## CS 390

**COD. 883690**

Displacement	37.2 cc
Carburator	Walbro
Power	1.2 kW
Bar length and chain	16" (40 cm)
Chain brake	yes
Chain lubrication	Automatic
Handle	Anti-vibration
Chain code	SE3L-57DL
Bar code	S16E3PP57
Weight*	4.6 kg
<b>Retail price</b>	<b>€ 170 - € 205,70*</b>



\* Weight without mixture, bar and chain

## CS 460

**COD. 883700**

Displacement	45.2 cc
Carburator	Walbro
Power	1.5 kW
Bar length and chain	18" (45 cm)
Chain brake	yes
Chain lubrication	Automatic
Handle	Anti-vibration
Chain code	SG5-72DL
Bar code	S18G5SE72
Weight*	5.4 kg
<b>Retail price</b>	<b>€ 180 - 217,80</b>



\* Weight without mixture, bar and chain

## CS 590

**COD. 883710**

Displacement	54 cc
Carburator	Hualong
Power	2.2 kW
Bar length and chain	20" (50 cm)
Chain brake	yes
Chain lubrication	Automatic
Handle	Anti-vibration
Chain code	SG5-78DL
Bar code	CSP550-186
Weight*	5.4 kg
<b>Retail price</b>	<b>€ 190 - € 229,90*</b>



\* Weight without mixture, bar and chain



## CSP 270 T / CSP 270 TC

	<b>COD. 884400</b>	<b>COD. 884440</b>
Displacement	25 cc	25 cc
Power	0.9 kW	0.9 kW
Bar length	10" (25 cm)	10" (25 cm)
Chain type	3/8 LP - 1.3 mm	1/4 LP - 1.3 mm
Carburator	Walbro	Walbro
Carburetor primer	yes	yes
Side chain tensioner	yes	yes
Tank capacity mix	170 ml	170 ml
Chain oil tank capacity	140 ml	140 ml
Chain code	SE3L-40DL	CSP270TC-CHAIN
Bar code	S10E3PP40	CSP270TC-BAR
Weight*	2.45 kg	2.45 kg
<b>Retail price</b>	<b>€ 225 - € 272,25</b>	<b>€ 245 - € 296,45*</b>



\* Weight without mixture, bar and chain

CHAINSAWS / PRUNER

## CSP 280 T / CSP 280 TC

	<b>COD. 884000</b>	<b>COD. 884010</b>
Displacement	28.5 cc	28.5 cc
Power	1 kW	1 kW
Bar length	10" (25 cm)	10" (25 cm) carving
Chain type	3/8 mini 1.3 mm	1/4 1.3 mm
Chain lubrication	Automatic	Automatic
Carburator	Walbro	Walbro
Carter	metal	metal
Chain code	SE3L-40DL	S25-60DL
Bar code	S10E3PP40	CSP280TC-BAR
Weight	3.25 kg	3.25 kg
<b>Retail price</b>	<b>€ 230 - € 278,30*</b>	<b>€ 250 - € 302,50*</b>



\* Weight without mixture, bar and chain

## CSP 410

	<b>COD. 884030</b>
Displacement	41.4 cc
Power	1.85 kW
Bar length	16" (40 cm)
Chain type	3/8 1.3 mm
Chain lubrication	Adjustable
Carburator	Walbro
Carter	metal
Chain code	SG3-66DL
Bar code	S16G3SE66
Weight	5.2 kg
<b>Retail price</b>	<b>€ 270 - € 326,70*</b>



## CSP 500

**COD. 884050**

Displacement	50 cc
Power	2.2 kW
Bar length	18" (45 cm)
Chain type	0,325 1.5 mm
Chain lubrication	Adjustable
Carburatore	Walbro
Carter	metal
Chain code	SG5-72DL
Bar code	S18G5SE72
Weight	5.7 kg
<b>Retail price</b>	<b>€ 290 - € 350,90*</b>



## CSP 550

**COD. 884060**

Displacement	55 cc
Power	2.4 kW
Bar length	20" (50 cm)
Chain type	0,325 1.5 mm
Chain lubrication	Adjustable
Carburatore	Walbro
Carter	metal
Chain code	SG5-78DL
Bar code	CSP550-186
Weight	5.7 kg
<b>Retail price</b>	<b>€ 300 - € 363,00*</b>



## PTT 261

**COD. 883960**

Engine	2 tempi - 25.4 cc
Bar	3/8 LP 1.3 cm
Bar length pruner	34.2 cm
Shaft length	4.1 mt
Weight	9.1 kg
<b>Retail price</b>	<b>€ 370 - € 447,70*</b>







*For a professional  
cut*



CHAINSAWS / PRUNER



# CHAINSAWS ACCESSORIES

## CHAINS / 100 FT ROLL

### SARP

1/4" mini semi-chisel -1,1 mm 0,43"	<b>S2325</b>	€ 135,52*
1/4" - 1,3 mm - 0,50	<b>S25100</b>	€ 544,50*
3/8" anti-bounce 1,1 mm - 0,43	<b>SE1S100</b>	€ 314,90
3/8" anti-bounce 1,3 mm - 0,50	<b>SE3S100</b>	€ 314,90*
3/8" 1,3 mm - 0,50	<b>SE3L100</b>	€ 344,85*
325" semi-chisel - 1,1 mm - 0,43	<b>SG125</b>	€ 147,62*
325" 1,3 mm - 0,50	<b>SG3100</b>	€ 363,00*
325" 1,5 mm - 0,58	<b>SG5100</b>	€ 363,00*
325" 1,6 mm - 0,63	<b>SG6100</b>	€ 363,00*
325" 1,3 mm - 0,50	<b>SG3C100</b>	€ 397,73*
325" 1,5 mm - 0,58	<b>SG5C100</b>	€ 397,73*
325" 1,6 mm - 0,63	<b>SG6C100</b>	€ 397,73*
3/8" 1,3 mm - 0,50	<b>SD3100</b>	€ 372,92*
3/8" 1,5 mm - 0,58	<b>SD5100</b>	€ 363,00*
3/8" 1,6 mm - 0,63	<b>SD6100</b>	€ 363,00*
3/8" 1,3 mm - 0,50	<b>SD3C100</b>	€ 399,66*
3/8" 1,5 mm - 0,58	<b>SD5C100</b>	€ 399,66*
3/8" 1,6 mm - 0,63	<b>SD6C100</b>	€ 399,66*
404" 1,6 mm - 0,63	<b>SF6100</b>	€ 410,55*

### CONFEZIONATE

1/4" 1,1 mm - 56M	<b>S23-56DL</b>	€ 20,81*
1/4" 1,3 mm - 0,50 - 52 M	<b>S25-52DL</b>	€ 19,72*
1/4" 1,3 mm - 0,50 - 60 M	<b>S25-60DL</b>	€ 22,63*
1/4" 1,3 mm - 0,50 - 76 M	<b>S25-76DL</b>	€ 28,44*
1/4" 1,3 mm - 0,50 - 84 M	<b>S25-84DL</b>	€ 31,34*
3/8" mini LP 1,3 mm - 0,50 - 40 M	<b>SE3L-40DL</b>	€ 12,95*
3/8" mini LP 1,3 mm - 0,50 - 45 M	<b>SE3L-45DL</b>	€ 14,40*
3/8" mini LP 1,3 mm - 0,50 - 47 M	<b>SE3L-47DL</b>	€ 14,76*
3/8" mini LP 1,3 mm - 0,50 - 50 M	<b>SE3L-50DL</b>	€ 15,85*
3/8" mini LP 1,3 mm - 0,50 - 52 M	<b>SE3L-52DL</b>	€ 16,58*

3/8" mini LP 1,3 mm - 0,50 - 53 M	<b>SE3L-53DL</b>	€ 16,58*
3/8" mini LP 1,3 mm - 0,50 - 55 M	<b>SE3L-55DL</b>	€ 17,30*
3/8" mini LP 1,3 mm - 0,50 - 56 M	<b>SE3L-56DL</b>	€ 17,67*
3/8" mini LP 1,3 mm - 0,50 - 57 M	<b>SE3L-57DL</b>	€ 18,03*
3/8" mini LP 1,1 mm - 0,43 - 39 M	<b>SE1S-39DL</b>	€ 12,58*
3/8" mini LP 1,1 mm - 0,43 - 50 M	<b>SE1S-50DL</b>	€ 15,85*
3/8" mini LP 1,3 mm - 0,50 - 40 M	<b>SE3S-40DL</b>	€ 12,58*
3/8" mini LP 1,3 mm - 0,50 - 45 M	<b>SE1S-45DL</b>	€ 14,04*
3/8" mini LP 1,3 mm - 0,50 - 52 M	<b>SE3S-52DL</b>	€ 16,21*
3/8" mini LP 1,3 mm - 0,50 - 57 M	<b>SE3S-57DL</b>	€ 18,03*
3/8" 1,5 mm - 0,58 - 68 M	<b>SD5-68DL</b>	€ 24,44*
3/8" 1,5 mm - 0,58 - 72 M	<b>SD5-72DL</b>	€ 25,89*
3/8" 1,6 mm - 0,63 - 66 M	<b>SD6-66DL</b>	€ 23,72*
3/8" 1,6 mm - 0,63 - 72 M	<b>SD6-72DL</b>	€ 25,89*
3/8" 1,5 mm - 0,58 - 68 M	<b>SD5C-68DL</b>	€ 26,62*
3/8" 1,5 mm - 0,58 - 72 M	<b>SD5C-72DL</b>	€ 28,07*

325" 1,3 mm - 0,50 - 64 M	<b>SG3-64DL</b>	€ 20,45*
325" 1,3 mm - 0,50 - 66 M	<b>SG3-66DL</b>	€ 21,18*
325" 1,3 mm - 0,50 - 72 M	<b>SG3-72DL</b>	€ 22,99*
325" 1,5 mm - 0,58 - 64 M	<b>SG5-64DL</b>	€ 21,18*
325" 1,5 mm - 0,58 - 66 M	<b>SG5-66DL</b>	€ 21,90*
325" 1,5 mm - 0,58 - 68 M	<b>SG5-68DL</b>	€ 22,99*
325" 1,5 mm - 0,58 - 72 M	<b>SG5-72DL</b>	€ 24,08*
325" 1,6 mm - 0,63 - 62 M	<b>SG6-62DL</b>	€ 20,08*
325" 1,6 mm - 0,63 - 67 M	<b>SG6-67DL</b>	€ 21,54*
325" 1,6 mm - 0,63 - 68 M	<b>SG6-68DL</b>	€ 21,90*
325" 1,6 mm - 0,63 - 74 M	<b>SG6-74DL</b>	€ 23,72*
325" 1,3 mm - 0,50 - 72 M	<b>SG3C-72DL</b>	€ 25,17*
325" 1,5 mm - 0,58 - 78 M	<b>SG5-78DL</b>	€ 27,35*

## ECOLOGIC CHAIN PROTECTIVE OIL



5 lt bottle **COD. 210120** € 29,04\*

## PROTECTION GOGGLES



**COD. 21023** € 9,68\*

## EAR PROTECTORS



Extra-light 140 gr **COD. 122505** € 12,10\*



# CHAINSAWS ACCESSORIES



## BARS



25 cm 10" 40 drive links 3/8"LP 1.1mm	<b>S10E3MP40</b>	€ 19,00*
25 cm 10" 40 drive links 3/8"LP 1.3mm	<b>S10E3PP40</b>	€ 19,00*
30 cm 12" 45 drive links 3/8"LP 1.3mm	<b>S12E3PP45</b>	€ 19,00*
35 cm 14" 52 drive links 3/8"LP 1.3mm	<b>S14E3PP52</b>	€ 21,18*
35 cm 14" 50 drive links 3/8"LP 1.3mm	<b>S14E3PT50</b>	€ 21,18*
40 cm 16" 57 drive links 3/8"LP 1.3mm	<b>S16E3PP57</b>	€ 23,35*
40 cm 16" 55 drive links 3/8"LP 1.3mm	<b>S16E3PT55</b>	€ 23,35*
38 cm 15" 64 drive links 3/8"LP 1.3mm	<b>S15G3SU64</b>	€ 31,94*
40 cm 16" 66 drive links 3/8"LP 1.3mm	<b>S16G3SE66</b>	€ 31,94*
45 cm 18" 72 drive links 3/8"LP 1.3mm	<b>S18G3SU72</b>	€ 36,30*
38 cm 15" 64 drive links 3/8"LP 1.5mm	<b>S15G5SU64</b>	€ 31,94*
40 cm 16" 66 drive links 3/8"LP 1.5mm	<b>S16G5SU66</b>	€ 36,30*
40 cm 16" 66 drive links 3/8"LP 1.5mm	<b>S16G5SE66</b>	€ 29,30*
45 cm 18" 72 drive links 3/8"LP 1.5mm	<b>S18G5SE72</b>	€ 36,30*
45 cm 18" 72 drive links 3/8"LP 1.5mm	<b>S18G5SU72</b>	€ 36,30*
40 cm 16" 66 drive links 3/8"LP 1.6mm	<b>S16G6SS67</b>	€ 31,94*
45 cm 18" 74 drive links 3/8"LP 1.6mm	<b>S18G6SS74</b>	€ 36,30*
38 cm 15" 56 drive links 3/8"LP 1.5mm	<b>S15D5SH56</b>	€ 31,94*
40 cm 16" 60 drive links 3/8"LP 1.5mm	<b>S16D5SH60</b>	€ 31,94*
43 cm 17" 64 drive links 3/8"LP 1.5mm	<b>S17D5SH64</b>	€ 36,30*
45 cm 18" 68 drive links 3/8"LP 1.5mm	<b>S18D5SH68</b>	€ 36,30*
50 cm 20" 72 drive links 3/8"LP 1.5mm	<b>S20D5SH72</b>	€ 40,29*
40 cm 16" 60 drive links 3/8"LP 1.6mm	<b>S16D6SS60</b>	€ 31,94*
45 cm 18" 66 drive links 3/8"LP 1.6mm	<b>S18D6SS66</b>	€ 36,30*
50 cm 20" 72 drive links 3/8"LP 1.6mm	<b>S20D6SS72</b>	€ 40,29*

## ROUND FILES



Round files 4,8 mm (3/16 inch)	<b>L3</b>	€ 44,53*
Round files 4 mm (5/32 inch)	<b>L5</b>	€ 44,53*
Round files 5,5 mm (7/32 inch)	<b>L7</b>	€ 44,53*
Round files 3,3 mm (1/8 inch)	<b>L18</b>	€ 44,53*



## MULTI TANK



Versatile tank 5 Lt mixture and 3 Lt oil, spouts with automatic stop and anti-splash included. **COD. 755130** € 43,20



# WINCHES



- Allows you to pull or tow heavy loads thanks to the winding of a rope.
- The ropes used can be made of polyester, steel or kevlar.
- Compact professional tools suitable for the most complex forestry work.



**01. Inspection window** to be able to check the correct winding of the rope.

**02. Turning hook** for greater versatility.

**03. Rope guide** to carry out the rope winding operation automatically.

**04. Quick coupling** to unlock and lock the cable drum in order to unwind it more quickly.

**05. Anti-vibration handle** for greater ergonomics.



# TW 610 ST / TWH 500

	<b>COD. 887450</b>	<b>COD. 883500</b>
Engine	ST POWER 2-stroke *	Honda 4 stroke
Displacement	57.9 cc	47.9 cc
Power	2.8 kW/7500 rpm	1.47 kW/7000 rpm
Suggested rope	Polyester Ø 10 mm <b>not included</b>	Polyester Ø 10 mm <b>not included</b>
Rope winding speed	25 metres/min.	25 metres/min.
Direct pulling	600 kg	400 kg
Weight	10.5 kg	9.9 kg
<b>Retail price</b>	<b>€ 825 - € 998,25*</b>	<b>€ 850 - € 1.028,50*</b>



\* 2% mixture with synthetic oil

# FW 1610 ST / FW 1610 STK

	<b>COD. 887460</b>	<b>COD. 887580</b>
Engine	ST POWER 2 tempi *	ST POWER 2 tempi *
Displacement	57.9 cc	57.9 cc
Power	2.8 kW/7500 rpm	2.8 kW/7500 rpm
Drum capacity	80 metres. Ø 5 mm steel cable Included	80 metres. Ø 5 mm Kevlar rope Included
Rope winding speed	25 metres/min.	25 metres/min.
Direct pulling	1300 kg	1300 kg
Pulling with support pulley	2600 kg	2600 kg
Rope guide	yes	yes
Automatic brake	yes	yes
Weight	35 kg including cable	28 kg including cable
<b>Retail price</b>	<b>€ 1.900 - € 2.299,00*</b>	<b>€ 2.095 - € 2.534,95*</b>



\* 2% mixture with synthetic oil

## ACCESSORIES FOR WINCHES

Backpack for TW 610 ST winch	<b>COD. 731080</b>	<b>€ 157,30*</b>
Polyester rope Ø 10 mm x 50 mt	<b>COD. 630230</b>	<b>€ 133,10*</b>
Polyester rope Ø 10 mm x 100 mt	<b>COD. 630330</b>	<b>€ 260,15*</b>
Steel cable for FW 1610 ST winch	<b>COD. 630280</b>	<b>€ 193,60*</b>
Dyneema-kevlar rope Ø 5mm x 80 mt	<b>COD. 630340</b>	<b>€ 459,80*</b>
1300 kg pulley	<b>COD. 392550</b>	<b>€ 151,25*</b>
Anchoring belt 1 mt - 2000 kg	<b>COD. 630290</b>	<b>€ 18,15*</b>
Anchoring belt 2 mt - 2000 kg	<b>COD. 630300</b>	<b>€ 22,99*</b>
2 tons cricket	<b>COD. 392520</b>	<b>€ 10,89*</b>



BACKPACK FOR WINCH



ROPE



PULLEY



CRICKET



BELT



## LOG SPLITTERS



- The range features models with both horizontal and vertical splitting, some equipped with an electric motor, others with a petrol engine.
- They allow you to effectively split logs effortlessly.
- The horizontal log splitters are equipped with a grid guard plate for total user safety.
- The vertical log splitters are equipped with a wheel kit and a sturdy and safe handle for moving on the ground.

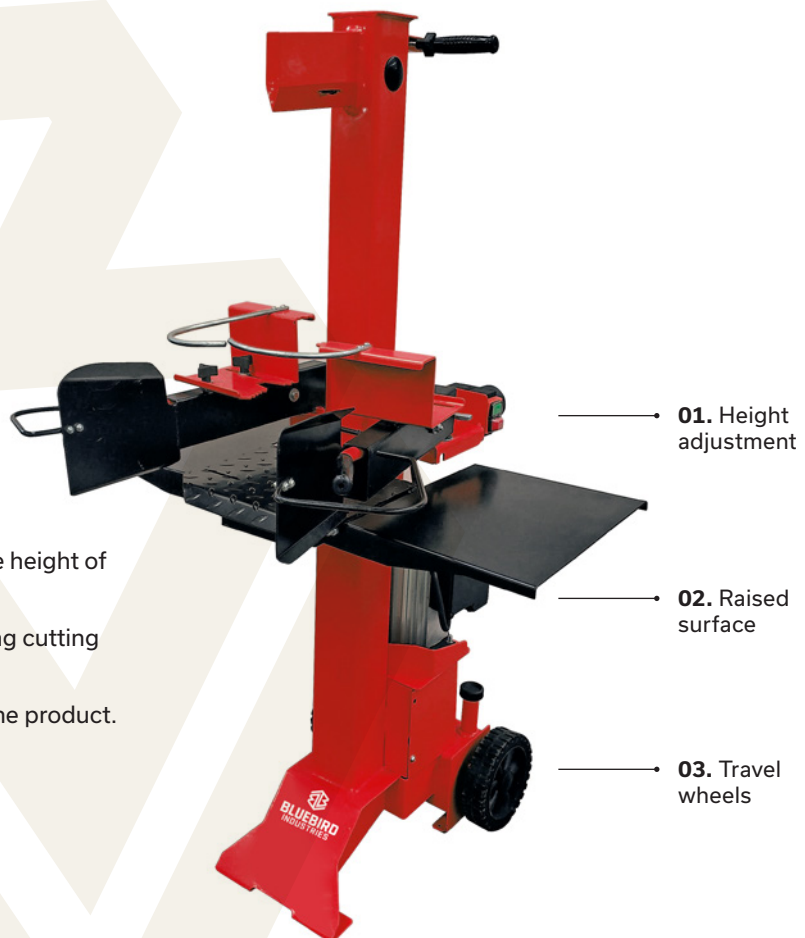

- 01. Wedge height adjustment** to customize the height of the wedge that will cut the wood.
- 02. Raised surface:** allows greater control during cutting operations.
- 03. Transport wheels:** make it easier to move the product.

01. Height adjustment

02. Raised surface

03. Travel wheels



# LSE 5000



LOG SPLITTERS

**COD. 883290**

Engine	single phase 2200W / 230V
Splitting length	520 mm
Splitting diameter	250 mm
Splitting force	5 ton
Weight	50 kg
<b>Retail price</b>	<b>€ 459,80*</b>



# LSHE 7000

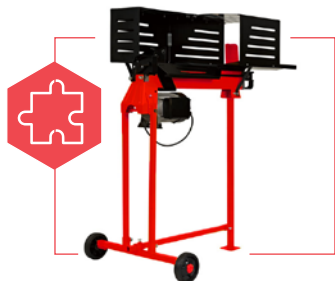

**LOG SPLITTER SUPPORT**  
LSHE 7000

**COD. 754820** € 54,45\*

*Comfortable  
log splitting*

- Engine single phase 2300W / 230V
- Cutting modes: horizontal
- Splitting force: 7 ton

**COD. 886010**

Engine	single phase 2300W / 230V
Splitting length	520 mm
Splitting diameter	250 mm
Splitting force	7 ton
Weight	59 kg
<b>Retail price</b>	<b>€ 410 - € 496,10*</b>





## LSE 7000 / LSE 8000

- Engine single phase 3000W / 230V
- Cutting modes: vertical
- Splitting force: 7/8 ton

	<b>COD. 883300</b>	<b>COD. 883310</b>
Engine	single phase 3000W S6 / 230V	single phase 3000W S6 / 230V
Splitting length	550 mm	550 mm
Splitting diameter	300 mm	300 mm
Splitting force	7 ton	8 ton
Weight	98.2 kg	110 kg
<b>Retail price</b>	<b>€ 680 - € 822,80*</b>	<b>€ 760 - € 919,60</b>



## LSE 11000

*For tough timber*

	<b>COD. 883730</b>
Engine	single phase 3000W / 230V
Splitting length	1040 mm
Splitting diameter	300 mm
Splitting force	11 ton
Weight	174 kg
<b>Retail price</b>	<b>€ 1.170 - € 1.415,70*</b>





# LSL 16000 / LSL 22000



LOG SPLITTERS

	<b>COD. 884110</b>	<b>COD. 884120</b>
Engine	Loncin 6.5 Hp	Loncin 10 Hp
Splitting length	1100 mm	1100 mm
Splitting diameter	300 mm	350 mm
Splitting force	16 ton	22 ton
Weight	248.5 kg	299.5 kg
Retail price	€ 2.150 - € 2.601,50*	€ 2.670 - 3.230,70*



# LS PTO 30000

	<b>COD. 884350</b>
Engine	PTO - tractor mounted
Splitting length	1100 mm
Splitting diameter	400 mm
Splitting force	30 ton
Weight	346 kg
Retail price	€ 3.190 - € 3.859,90





# SHREDDERS



- Keeping the green space clean and tidy is simple and immediate thanks to garden shredders.
- Compact structure ideal for disposing of pruning residues from trees, bushes, hedges and brambles.
- Reduce twigs and scrub so they are suitable for composting.
- They crush the material in a small space, also reducing the time required for decomposition.
- Perfect for producing humus to keep your soil and plants healthy.



- 01. Double knife disc for effective shredding.**
- 02. Deflector** for adjustable discharge.
- 03. Pneumatic wheels** for simpler transport.



01. Blade disc

02. Deflector

03. Pneumatic wheels



## SHL 700

- Loncin engine with 196 cc displacement
- Double knife disc 2600 rpm
- Travel wheels included

**COD. 886020**

Engine	Loncin 6.5 Hp
Displacement	196 cc
Max cutting branch Ø	7 cm
Rotor diameter	400 x 10 mm
2 cutters size	110 x 42 x 9 mm
Rotation speed	2600 al/min
Loading hole size	530 x 350 mm
Output hole size	150 x 150 mm
Vibration level	5.52 m/s
Travel wheels	n 2
Weight	90 kg
<b>Retail price</b>	<b>€ 1.020 - € 1.234,20*</b>



## SH 2500

- Electric motor with 2500W power
- Drum cutting system for better shredding
- Basket for collecting the shredded material
- Trolley with wheels for easy movement

**COD. 880450**

Engine	Electric 2500W - 230V - 50Hz
Cutting system	Drum
Max cutting branch Ø	4 cm
Collecting basket	included
Reverse speed	included
Trolley with wheels	included
Blade regulation	included
Weight	40 kg
<b>Retail price</b>	<b>€ 380 - € 459,80*</b>



# WOOD CHIPPERS



- Designed for grinding branches, logs and other biodegradable waste from the ground.
- Ideal for all those who need to do green maintenance and who need to grind quickly after pruning.
- Crushing the material reduces the time required for decomposition.
- Excellent for fast and professional green maintenance.



- 01. Shredding drum:** composed of two 233 mm blades, it allows the shredding of large diameters.
- 02. The large loading hopper** allows the insertion of the product to be processed with extreme ease.
- 03. The output** of the processed product can be directed in different directions.



## SHL 1000

**COD. 884540**

Engine	Loncin V200F
Power	6.5 hP – 3600 rpm
Fuel	Gasoline
Starting	Rope
Cutting system	Drum (2 Blade 233 mm)
Branches max diam	100 mm
Length	1760 mm
Width	513 mm
Height	1105 mm
Wheels size	4.10-3.50-4
Weight	108 kg
<b>Retail price</b>	<b>€ 1.100 - € 1.331,00*</b>



WOOD CHIPPERS

## SHL 1200

**COD. 884520**

Engine	Loncin G420F
Power	9 kW – 3600 rpm
Fuel	Gasoline
Starting	Electric
Cutting system	Drum (2 Blade 233 mm)
Branches max diam	120 mm
Length	2560 mm
Width	890 mm
Height	1480 mm
Wheels size	16x8.0-7
Weight	200 kg
<b>Retail price</b>	<b>€ 2.050 - 2.480,50*</b>



# 310-SHL 1200

**884530**

Engine	Loncin G420F	Loncin V200
Power	15 hP – 3600 rpm	6.5 hP
Fuel	Gasoline	Gasoline
Starting	Electric	Rope
Cutting system	Drum (2 Blade 233 mm)	
Branches max diam	120 mm	
Length	2560 mm	
Width	890 mm	
Height	1480 mm	
Misure Wheels	16x8.0-7	
Weight	200 kg	140 kg
<b>Retail price</b>	<b>€ 3.900 - € 4.719,00*</b>	

**CARRIER BOX****COD. D30MB-47 € 423,50\***

# SHL 1500

**COD. 888390**

Engine	Loncin G420FD
Power	15 hP – 3600 rpm
Fuel	Gasoline
Starting	Electric
Cutting system	Drum (2 Blade 233 mm)
Branches max diam	150 mm
Misure Wheels	17x7.0-8
Weight	255 kg
<b>Retail price</b>	<b>€ 2.400 - € 2.904,00*</b>









## SAW BENCHES



- These machines are designed to deliver reliable performance and precise cuts in a variety of materials, ensuring a clean and consistent cut.
- Items that can handle demanding workloads without sacrificing cut quality ensuring fast and efficient material processing.
- IP54 degree of protection against dust and liquids ensures that the machine is resistant even in the most difficult conditions.
- Compact products ideal for use in small areas or on construction sites

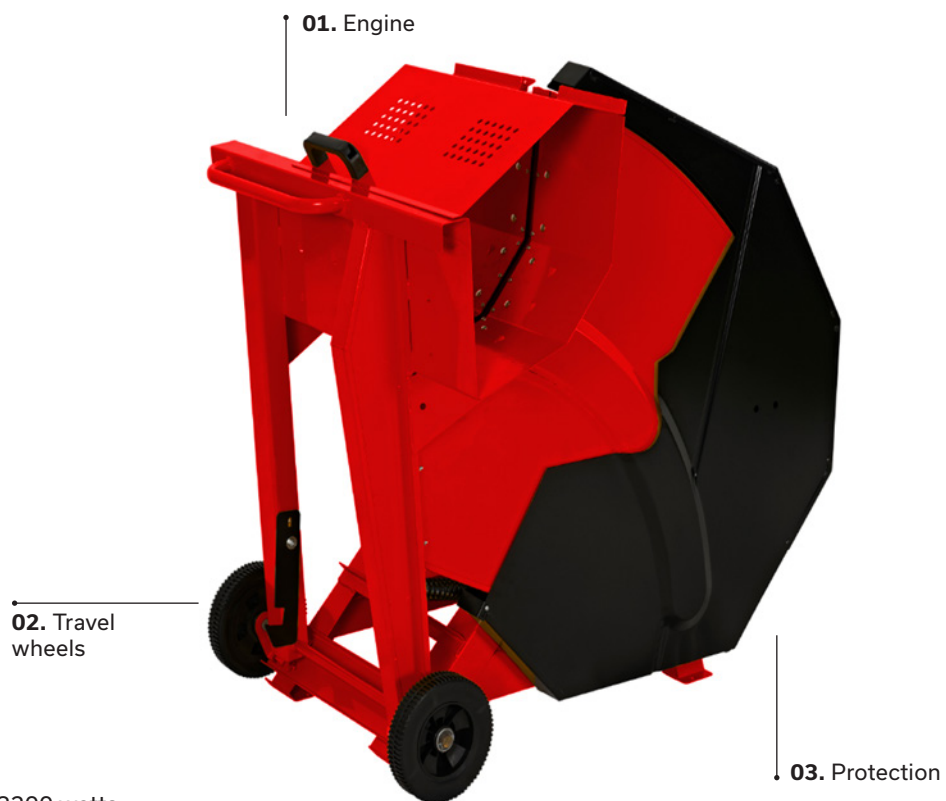
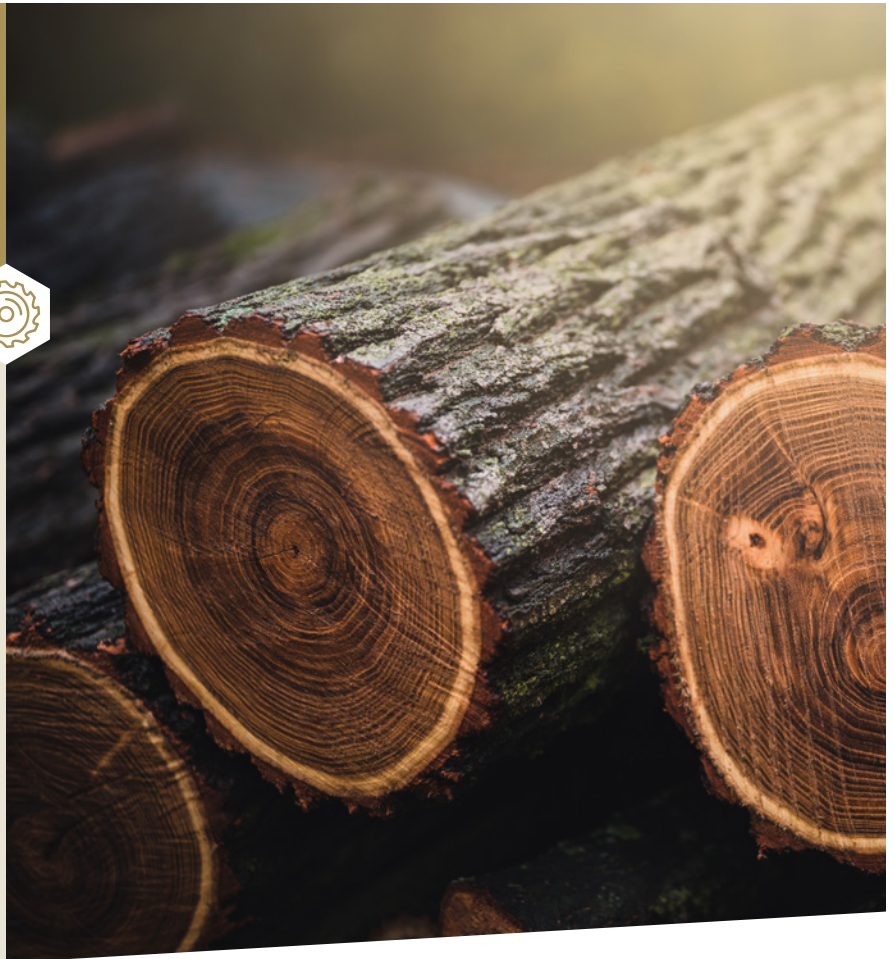

**01. Engine:** powerful with 3200 watts

**02. Transfer wheels:** that allow easy transport

**03. Protection:** for more safety



## SAW BENCH 140 MM

**COD. 888400**

Engine	230V, 50Hz
Cutting blades	ø405xø30 mm
Cutting size	140 mm
Power	2200W
Protection rate	dust, liquids IP54
Blade rotations	2800/min
Weight	36.3 kg
<b>Retail price</b>	<b>€ 320 - € 387,20</b>



## SAW BENCH 170 MM

**COD. 888410**

Engine	230V, 50Hz
Cutting blades	ø505xø30 mm
Cutting size	170 mm
Power	3000W
Protection rate	dust, liquids IP54
Blade rotations	2800/min
Weight	56.3 kg
<b>Retail price</b>	<b>€ 530 - € 641,30*</b>



## SAW BENCH 250 MM

**COD. 888420**

Engine	230V, 50Hz
Cutting blades	ø700xø30 mm
Cutting size	250 mm
Power	3200W
Protection rate	dust, liquids IP54
Blade rotations	1400/min
Weight	93 kg
<b>Retail price</b>	<b>€ 830 - € 1.004,30</b>





## WHEN CARGO IS VALUABLE

Working in orchards, olive groves and vineyards requires continuous dedication and a range of specific equipment to take care of the plants efficiently and in short time. A very important machine for this activity is the crawler carrier, the flagship product of the Blue Bird agriculture line. Because of its size and manoeuvrability, it is the perfect tool for working on terracing, on steep slopes and with limited manoeuvring space.

The Blue Bird line for farming is especially aimed at all those who care for fruit trees, olive groves and vineyards.

All Blue Bird products are designed to make the work of caring, cutting and transportation easier while protecting the natural environment. They are made to last while always bearing excellent fruit.





## ALL-ROUND

Blue Bird's line dedicated to agriculture includes all those essential products for managing fruit trees: from harvesters to Olive shakers, from pruning shears to tying machines. And once the load is complete, Blue Bird Crawler carriers take care of moving loads wherever you want them, even on steep slopes.

*Always bearing  
excellent fruit*

# FARMING

Olive Harvesters

PAG 114

Olive Shakers

PAG 116

Carriers

PAG 118



# OLIVE HARVESTERS



- The range includes both battery and electric models for professional use.
- Light and fast tools for olives harvesting, with high frequency lateral movement.
- Opposed motion system of the combs.
- The models with telescopic shaft reach 3 meters length.

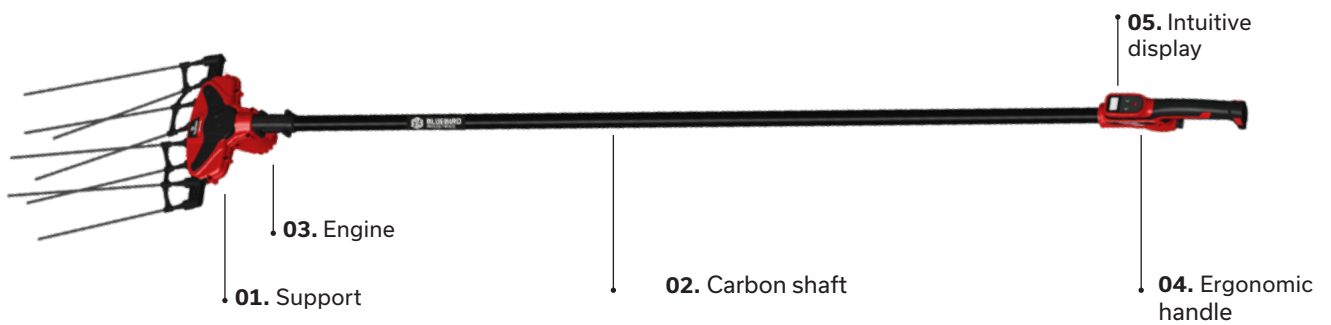

**01. Support:** 10' inclined.

**02. Carbon shaft:** which guarantees extreme lightness

**03. Engine:** with power of 750W

**04. Ergonomic handle:** for excellent comfort during use

**05. Intuitive display:** with usage information available



# EGEO 22-50



BATTERY  
PRO 12 V



**COD. 888060**

Working voltage	12 V
Power	750 W
Speed adjustment	2 modes
Cable length	12 m
Working width	500 mm
Shaft	Fixed
Shaft material	Carbon/Aluminium
Shaft length	2400 mm
Sticks	4+4
Control panel	Display OLED
Weight (battery excluded)	2.3 kg
<b>Retail price</b>	<b>€ 340 - € 411,40</b>



**The EGEO 22-50 model is supplied without battery and charger.**



OLIVE HARVESTERS

# EGEO 22-50 AT



BATTERY  
PRO 12 V

**COD. 888360**

Working voltage	12 V
Power	750 W
Speed adjustment	2 modes
Cable length	12 m
Working width	500 mm
Shaft	Telescopic
Shaft material	Carbon
Length min/max	2.200-3.100 mm
Sticks	4+4
Control panel	Display OLED
Weight (battery excluded)	2.6 kg
<b>Retail price</b>	<b>€ 365 - € 441,65*</b>



**The EGEO 22-50 AT model is supplied without battery and charger.**





# OLIVE SHAKERS





# OS 610 TV-TVT-TVTS



OLIVE SHAKERS

*The right shake*

- Ideal tools for harvesting olives or hanging fruit in general.
- The integrity of the plant is guaranteed thanks to its system of hooking and shaking the branch.
- The vibrating hook allows you to shake branches at heights of several meters, protecting the user from vibrations



	<b>COD. 887530/887540/RO</b>	<b>COD. 887550/RO</b>	<b>COD. 887560/RO</b>
Engine ST POWER	2-stroke*	2-stroke*	2-stroke*
Displacement	57.9 cc	57.9 cc	57.9 cc
Power	2.8 kW/7500 rpm	2.8 kW/7500 rpm	2.8 kW/7500 rpm
Tipo asta	Standard with vibrating head	Telescopic with vibrating head	Telescopic with vibrating head SUPER-SHAKE
Length asta	1800 mm / 2800 mm	1700 - 2500 mm	1700 - 2500 mm
Backpack	included	included	included
Handle	Anti-vibration	Anti-vibration	Anti-vibration
Weight**	13.1 kg / 13.3 kg	13.5 kg	13.7 kg
<b>Retail price</b>	<b>€ 1.371,66* / € 1.434,58*</b>	<b>€ 1.875,02*</b>	<b>€ 2.114,11*</b>

\* 2% mixture with synthetic oil  
\*\* Weight without mixture



# CARRIERS



- Blue Bird Industries carriers are faithful workmates in all situations where it is necessary to move heavy loads easily, even on steep slopes.
- The compact dimensions make them ideal for use on terraces and areas with limited maneuvering space.
- Details such as the track tensioning springs, the piston which helps the operator in tipping over the body and the extendable and removable sides, make Blue Bird carriers complete and extremely reliable machines.



**01. Accelerator lever:** the mechanical transmission is robust and resistant, with a gearbox with 3 forward and 1 reverse gears.

**02. Extendable sides:** allow increasing in the load volume.

**03. Tracks protection:** guarantees greater sturdiness even on difficult routes.

**04. Dumper box overturning lever:** simple control that offers ease of unloading.



## 300 / 350

	<b>COD. 881910</b>	<b>COD. 886890</b>
Engine	Loncin - 4 stroke	Honda GP160
Displacement	196 cc	163 cc
Power	6.5 Hp	4.8 Hp
Trasmission	3 forward speeds + reverse	3 forward speeds + reverse
Load capacity	300 kg	300 kg
Dumper box dimensions	910÷1040 x 600÷860	907÷1040 x 600÷860
Dumper box height	204 mm + sides	204 mm + sides
Dumper overturning	Manual with piston	Manual with piston
Track width	180 mm with track tension springs	180 mm with track tension springs
Weight	178 kg	178 kg
Snow blade	optional	optional
<b>Retail price</b>	<b>€ 1.950 - 2.359,50</b>	<b>€ 2.170 - € 2.625,70*</b>



## 500 / 500 H / 550

	<b>COD. 883090</b>	<b>COD. 885160</b>	<b>COD. 886900</b>
Engine	Loncin	Loncin	Honda GP200
Displacement	196 cc	196 cc	196 cc
Power	6.5 Hp	6.5 Hp	5.8 Hp
Trasmission	3 forward speeds + reverse	3 forward speeds + reverse	3 forward speeds + reverse
Load capacity	500 kg	500 kg	500 kg
Dumper box dimensions	1025÷1150 x 625÷885	1025÷1155 x 625÷885	1025÷1150 x 625÷885
Dumper box height	325 mm + sides	325 mm + sides	325 mm + sides
Dumper overturning	Manual with piston	Hydraulic	Manual with piston
Track width	180 mm with track tension springs	180 mm with track tension springs	180 mm with track tension springs
Weight	228 kg	256.5 kg	228 kg
<b>Retail price</b>	<b>€ 2.230 - 2.698,30*</b>	<b>€2.950 - €3.569,50</b>	<b>€ 2.600 - 3.146*</b>



## 500 DH

	<b>COD. 883100</b>
Engine	Loncin - 4 stroke
Displacement	196 cc
Power	6.5 Hp
Trasmission	3 forward speeds + reverse
Load capacity	500 kg
Dumper box dimensions	950 x 680
Dumper box height	465 mm
Dumper overturning	Hydraulic
Track width	180 mm with track tension springs
Weight	256 kg
<b>Retail price</b>	<b>€ 2.950 - € 3.569,50*</b>



## 500 DLH

**COD. 884200**

Engine	Loncin 270 cc
Power	9 Hp
Trasmission	Hydro
Load capacity	500 kg
Dumper box dimensions	1065 x 715 mm
Dumper box height	660 mm
Dumper overturning	Hydraulic
Track width	180 mm
Shovel lift	80 kg
Weight	360 kg
<b>Retail price</b>	<b>€ 6.300 - € 7.623,00*</b>



## 500 DSH

**COD. 884190**

Engine	Loncin 196 cc
Power	6.5 Hp
Trasmission	6 forward - 2 reverse
Load capacity	500 kg
Dumper box dimensions	950 x 680
Dumper box height	465 mm
Dumper overturning	Hydraulic
Track width	180 mm
Weight	250 kg
<b>Retail price</b>	<b>€ 3.180 - 3.847,80*</b>



## WB 500 E



**BATTERY**  
48 V



**COD. 884550**

Engine Electric	1000W, 48V Engine Brushless
Braking system	Electromagnetic brake
Battery	48V 32Ah
Screen	Battery capacity + speed
Headlight power	30W
Working time	8-10 h
Charging time	6-7 h
Speed	High 0-5.0km/h, medium 0-4.2km/h, low 0-3.3km/h
Reverse	0-2.5km/h
Max carrying weight	500 kg
Box	Dumper
Dumper overturning	Manual with piston
Weight	165 kg
<b>Retail price</b>	<b>€ 2.300 - € 2.783,00*</b>





# WB 500 EH

 BATTERY  
48 V

**COD. 884560**

Engine Electric	1000W, 48V Engine Brushless
Braking system	Electromagnetic brake
Battery	48V 32Ah
Screen	Battery capacity + speed
Headlight power	2 pieces 30W
Working time	8-10 h
Charging time	6-7 h
Charging current	4.5 A
Speed	High 0-5.0km/h, medium 0-4.2km/h, low 0-3.3km/h
Reverse	0-2.5km/h
Max carrying weight	500 kg
Box	Dumper+
Dumper overturning	Elettro Hydraulic
Weight	180KG
<b>Retail price</b>	<b>€ 2.700 - € 3.267,00*</b>



CARRIERS

# WB 500 EB

 BATTERY  
48 V

**COD. 884570**

Engine Electric	1000W, 48V Engine Brushless
Braking system	Electromagnetic brake
Battery	48V 32Ah
Screen	Battery capacity + speed
Headlight power	30W
Working time	8-10 h
Charging time	6-7 h
Charging current	4.5 A
Speed	High 0-5.0km/h, medium 0-4.2km/h, low 0-3.3km/h
Reverse	0-2.5km/h
Max carrying weight	500 kg
Box	Standard box
Dumper overturning	Manual with piston
Weight	180KG
<b>Retail price</b>	<b>€ 2.400 - € 2.904,00*</b>



## CARRIERS ACCESSORIES

Snow blade for CARRIER 300	<b>COD. 754380</b>	<b>€ 302,50*</b>
Snow blade for CARRIER 500	<b>COD. 754740</b>	<b>€ 411,40*</b>

Log carrier for CARRIER 300	<b>COD. 16732</b>	<b>€ 272,25*</b>
Log carrier for CARRIER 500	<b>COD. 16752</b>	<b>€ 435,60*</b>
Log carrier for CARRIER 500H	<b>COD. 16753</b>	<b>€ 435,60*</b>





## **EVEN FOR CONSTRUCTION INDUSTRY**

The Blue Bird soil line aims to offer the optimal solution for those involved in agricultural and forestry work but also in demolition, excavation, redevelopment and general construction. The line includes power augers, power drills, motor hoes, and mulchers ready to intervene even in inaccessible and difficult to reach places.

When work gets tough you need the right tools. With mulchers, the latest additions to the Blue Bird range, mowing operations where grass is tall and packed, where bushes or a thick undergrowth are present, are no longer a problem. The mulchers, manoeuvrable and powerful, like the entire Blue Bird soil line, offer power and solutions.





## THE BASIS OF ANY PROJECT

Preparing the soil well is the key step in ensuring excellent results. Blue Bird has designed a line of products specifically to support individuals and professionals to manage the soil but also to drill, demolish, remove. Working has never been easier.

*A range that leaves its mark*

# SOIL

Mini Excavator	PAG 124
Earth Augers	PAG 126
Motor Drills	PAG 130
Motor Tillers	PAG 132



## MINI EXCAVATOR



- Versatile machine for digging, lifting and moving materials in confined spaces or difficult to access. Widely used in construction, farming, landscaping and infrastructure maintenance.
- The mini excavator is versatile, suitable for digging foundations, trenches, drainage channels, leveling land, loading and unloading materials on vehicles and much more.
- The control station of the mini excavator has intuitive controls, safety devices such as anti-tipping systems and parking brake with Hydraulic lock for greater safety during parking and stopping.



- 01. Bucket:** 290 mm width with 0.011 m<sup>3</sup> capacity for good collection capacity
- 02. Engine:** powerful 306 cc engine
- 03. Speed and power:** with a running speed of 2,1 km/h and a traction force of 4,36 kN
- 04. Rubber trucks:** width of 150 mm that give stability and mobility
- 05. Control station:** with intuitive and accessible controls
- 06. Weight:** operating weight of 562 kg, can handle a wide range of tasks



# MEX 600



- The powerful 306 cc engine at gasoline provides the power needed for excavation activities. Starting is via key, offering an easy start and shut down of the Engine. In addition, there is also a Starting RECOIL system to ensure greater reliability.
- Hydraulic brake
- The bucket width is 290 mm with a capacity of 0.011 m<sup>3</sup>

*Scavare a fondo*

MINI EXCAVATOR

COD. 888140	
Engine	Gasoline - 306 cc
Power	6.3 kW
Bucket capacity	0.011 m <sup>3</sup>
Bucket width	290 mm
Digging force (arm)	4.75 kN (485 kgf)
Digging force (bucket)	8 kN (815 kgf)
Digging depth	1.2 mt
Starting	key, ignition and switching off + RECOIL
Forward speed	2.1 km/h
Traction power	4.36 kN
Swing speed	7.5 rpm
Slope	25°
Contact pressure with soil	26.3 kPa (0.27 kgf/cm <sup>2</sup> )
Arm swing	swing SX 70° / DX 70°
Movement mode	Rubber track
Track width	150 mm
Pump capacity	2 x 9 L/min
Fuel tank	9 L
Brake	Hydraulic
Operating weight	562 kg
<b>Retail price</b>	<b>€ 6.990 - € 8.457,90*</b>



## ACCESSORIES

### GRAB

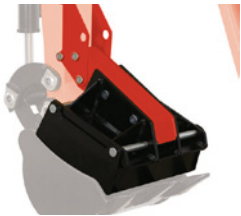

COD. 31312 € 217,80\*

### RAKE



COD. 32180 € 272,25\*

### SHOVEL STOP



COD. 31310 € 84,70\*

### FORK

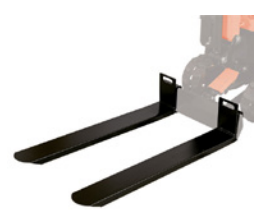

COD. 31315 € 308,55\*

### ROLL BAR + CANOPY



COD. 31305 € 441,65\*

### BUCKET 20 CM



COD. 31309 € 145,20\*

### LEVELLING BUCKET



COD. 31308 € 169,40\*



## EARTH AUGERS



- Ideal for the preparation of land intended for piling, reforestation, planting of fruit trees on hills or in the mountains even in conditions of steep slopes.
- Suitable for agriculture, forestry, nurseries and construction sites.
- Drills in thick steel as well as the tip and the knife to ensure professional workmanship.



### NEA HO 35 COD. 875490

HONDA MOTOR GX35

Handling by 1 person

35 cc, weight without auger 13 kg

Max diameter 25 cm

Max drilling depth 80 cm - 120 cm with extension

Auger included : no

Retail price: € 600 - € 726,00\*

### NEA HO 50 COD. 882600

HONDA MOTOR GX50

Handling by 1 person

50 cc, weight without auger 13 kg

Max diameter 25 cm

Max drilling depth 80 cm - 120 cm with extension

Auger included : no

Retail price: € 675 - € 816,75\*





## NEA 450 ST

**COD. 888000/RO**

Engine ST POWER	2-stroke* - 44.3 cc
Power	2.0 kW/7500 rpm
Max. drilling diameter	Ø 250 mm
Max. drilling depth	1.4 mt
Auger included	no
Weight**	10.7 kg
<b>Retail price</b>	<b>€ 585 - 707,85*</b>



\* 2% synthetic oil mixture  
\*\* Weight without mixture

EARTH AUGERS

## NEA 560 ST

**COD. 888010/RO**

Engine ST POWER	2-stroke* - 53.2 cc
Power	2.4 kW/7500 rpm
Max. drilling diameter	Ø 250 mm
Max. drilling depth	1.6 mt
Auger included	no
Weight**	10.7 kg
<b>Retail price</b>	<b>€ 605 - € 732,05*</b>



\* 2% synthetic oil mixture  
\*\* Weight without mixture

## NEA 610 ST

**COD. 888020/RO**

Engine ST POWER	2-stroke* - 57.9 cc
Power	2.8 kW/7500 rpm
Max. drilling diameter	Ø 250 mm
Max. drilling depth	1.8 mt
Auger included	no
Weight**	10.7 kg
<b>Retail price</b>	<b>€ 625 - € 756,25*</b>



\* 2% synthetic oil mixture  
\*\* Weight without mixture

# NEA 431

**COD. 883490**

Engine	2-stroke* - 42.7 cc
Power	1.25 kW/6500 rpm
Max. drilling diameter	Ø 250 mm
Max. drilling depth	1.2 mt
Auger included	no
Weight*	10.4 kg
<b>Retail price</b>	<b>€ 405 - € 490,05*</b>



\* 2% synthetic oil mixture  
\*\* Weight without mixture

# T 170 HO\*

**COD. 882650**

Engine Honda	GCV 170 4 stroke - 166 cc
Power	3.6 kW (4.8 Hp) 3600 rpm
Max. drilling diameter	Ø 400 mm
Max. drilling depth	2.0 mt
Reverse speed	yes
Auger included	no
Weight**	27 kg
<b>Retail price</b>	<b>€ 1.590 - € 1.923,90*</b>



\* T 170 HO must be operated by  
2 or more persons  
\*\* Weight without mixture

# 521-ESS

**COD. 888430**

Engine	1E40FN - 43 cc
Power	1.25 kW 6500 rpm
Max. drilling diameter	Ø 200 mm
Gearbox	40:1
Fuel tank capacity	0,98 L
Auger included	200x800
Weight**	9,8 kg
<b>Retail price</b>	<b>€ 275 - € 332,75*</b>







# TR WAVE



EARTH AUGERS

**COD. 887570**

Engine ST POWER	2-stroke* - 57.9 cc
Power	2.8 kW/7500 rpm
Tempered steel bit	77x77x900 mm
Max. drilling depth	0.9 mt
Auger included	yes
Weight*	18 kg
<b>Retail price</b>	<b>€ 1.590 - € 1.923,90*</b>

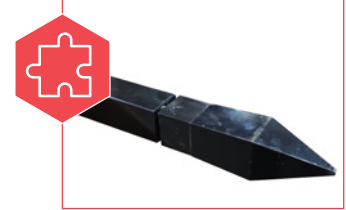
**BIT FOR TR WAVE77X77**
**COD. 727030R € 987,36\***

 \* 2% synthetic oil mixture  
 \*\* Weight without mixture

## EARTH AUGERS ACCESSORIES

### AUGER DRILL FOR NEA

Model	Ø mm	COD.	Price
80 x 800	80	COD . 720020	€ 127,05*
100 x 800	100	COD . 720040	€ 133,10*
120 x 800	120	COD . 720070	€ 145,20*
150 x 800	150	COD . 720170	€ 151,25*
180 x 800	180	COD . 720210	€ 187,55*
200 x 800	200	COD . 720350	€ 193,60*
250 x 800	250	COD . 727430	€ 272,25*



### EXTENSION

Without spiral for NEA

 Length 400 mm **COD . 750360 € 64,13\***

With quick coupling for T 170 HOHO

 Length 500 mm **COD. 751380 € 162,14\***

 Length 1000 mm **COD. 751390 € 188,76\***

### AUGER DRILL FOR NEA 521-ESS

Model	Ø mm	COD.	Price
80X800	80	COD . 755160	€ 60,50*
100X800	100	COD . 755170	€ 72,60*
150X800	150	COD . 755180	€ 84,70*
200X800	200	COD . 755140	€ 96,80*
250X800	250	COD . 755190	€ 121,00*



### AUGER DRILL FOR T 170 HO

one start

Model	Ø mm	COD.	Price
100 x 700	100	COD . 722000	€ 211,75*
150 x 700	150	COD . 722010	€ 260,15
100 x 1000	100	COD . 722140	€ 272,25
150 x 1000	150	COD . 722150	€ 302,50



### DRILLING BITS

 per NEA **COD. 750750 € 18,15\***

 per T170H **COD. 750760 € 21,78\***

### DIGGING CUTTERS

 Ø mm 80 **COD. 600470 € 14,52\***

 Ø mm 170 **COD. 600150 € 14,52\***

### AUGER DRILL FOR T 170 HO

two start

Model	Ø mm	COD.	Price
200 x 700	200	COD . 722020	€ 296,45*
250 x 700	250	COD . 722030	€ 326,70*
300 x 700	300	COD . 722040	€ 502,15*
350 x 700	350	COD . 722050	€ 550,55*
400 x 700	400	COD . 722060	€ 605,00*
200 x 1000	200	COD . 722160	€ 369,05*
250 x 1000	250	COD . 722170	€ 393,25*
300 x 1000	300	COD . 722180	€ 532,40*
350 x 1000	350	COD . 722190	€ 617,10*
400 x 1000	400	COD . 722200	€ 665,50*



### DIGGING CUTTERS

 Ø mm 120 **COD. 600450 € 14,52\***

 Ø mm 150 **COD. 600170 € 15,73\***

 Ø mm 180 **COD. 600460 € 16,94\***

 Ø mm 200 **COD. 600180 € 16,94\***

 Ø mm 250 **COD. 600190 € 18,15\***

 Ø mm 300 **COD. 600200 € 18,15\***

 Ø mm 350 **COD. 600210 € 22,99\***

 Ø mm 400 **COD. 600220 € 24,20\***



# MOTOR DRILLS



- State-of-the-art drilling or breaking tools.
- Thanks to the right balance between power and handling, they are also invaluable in extreme situations and not only on construction sites.
- The ergonomic design makes them easy to handle and suitable for all conditions.

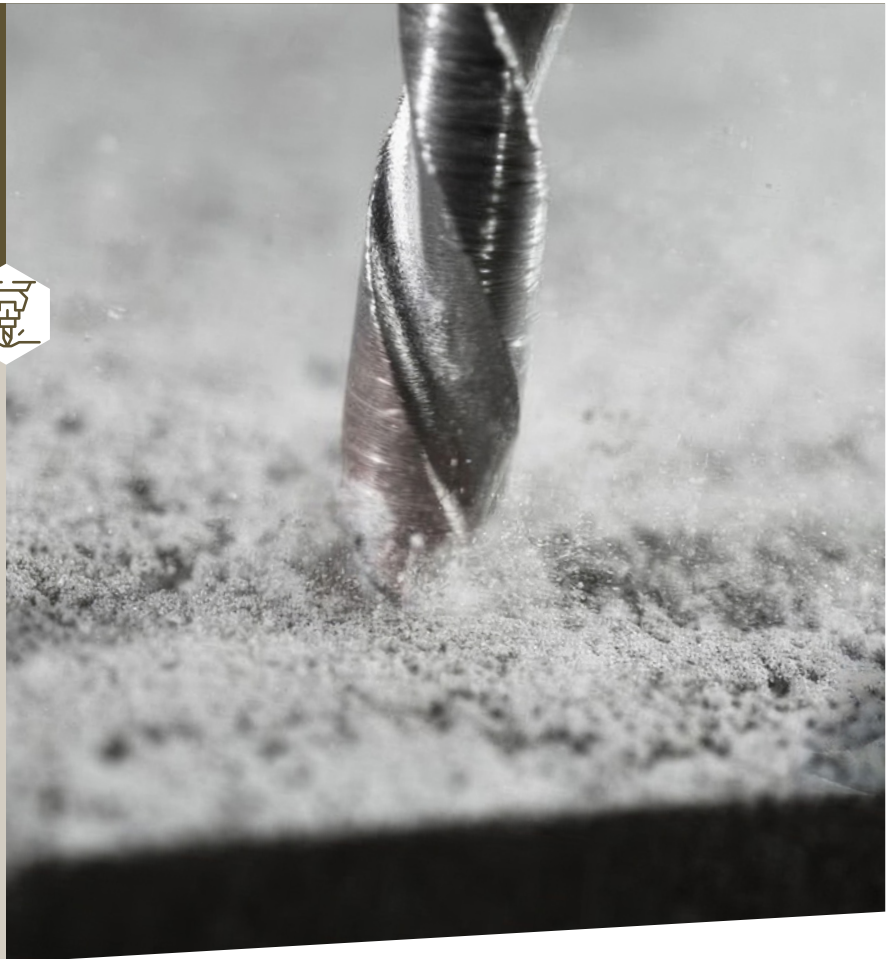

- 01. Handle:** guarantees increased grip and reduced vibrations.
- 02. Engine.** two types of engines are available: Honda and Blue Bird.
- 03. Drilling head:** Bosch hammer and SDS-max tool attachment.



# HB 26

**COD. 879480**

Engine Honda	GX 25 - 4 stroke OHC - 25 cc
Power	0.72 kW (1.0 Hp) 7000 rpm
Fuel	Gasoline
Beating unit	Bosch GBH 2-26
BPM	0-3900
Tools connection	SDS-plus
Drilling capacity	26 mm
Net weight*	6.5 kg
<b>Retail price</b>	<b>€ 1.845 - € 2.232,45*</b>



\* Weight without fuel

MOTOR DRILLS

# B HB 40

**COD. 883250**
**COD. 883670**

Engine	Honda GX 35 4 stroke OHC - 35.8 cc	Blue Bird 2 stroke - 44.3 cc
Power	1.0 kW (1.3 Hp) 7000 rpm	2 kW/7500 rpm
Fuel	Gasoline	Mixture
Beating unit	Bosch GBH 5-40 D	Bosch GBH 5-40 D
BPM	0-2900	0-2900
Tools connection	SDS-max	SDS-max
Capacità di perforazione	40 mm on concrete and helicoidal bit 55 mm on concrete and special bit 90 mm on masonry and front crown	40 mm on concrete and helicoidal bit 55 mm on concrete and special bit 90 mm on masonry and front crown
Net weight*	11 kg	11 kg
<b>Retail price</b>	<b>€ 2.840 - 3.436,40*</b>	<b>€ 2.840 - 3.436,40*</b>



\* Weight without fuel

# BB 52

**COD. 882020**

ST POWER Engine	2-stroke* - 53.2 cc
Power	2.4 kW/7500 rpm
Fuel	miscela 2% olio sintetico
Beating unit	Bosch UBH 12-520
BPM	0-2150
Tools connection	SDS-max
Drilling capacity	52 mm on concrete and helicoidal bit 55 mm on concrete and special bit 90 mm on masonry and front crown
Net weight*	15.3 kg
<b>Retail price</b>	<b>€ 3.835 - 4.640,35*</b>

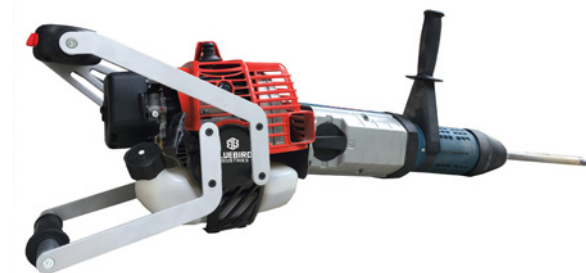

\* 2% mixture with synthetic oil \*\* Weight without fuel

# ZMJ260

**COD. 885710**

Engine	Loncin 23 cc
Power	0.6 kW/7000 rpm
Fuel tank	0,4 l
Net weight*	4.1 kg
<b>Retail price</b>	<b>€ 231 - € 279,51*</b>



\* Weight without fuel



## MOTOR TILLERS



- Professional machines which, thanks to the transmission with oil bath gears, guarantee solidity and durability over time.
- Suitable for working large and hard ground, as well as small areas, flowerbeds, vegetable gardens.
- The robust tillers guarantee operation in any terrain.
- Height and laterally adjustable handlebar provides maximum working comfort.



01. Height and laterally **adjustable handle**.
02. **Engine**: wide range of engines: Honda, Loncin.
03. **Gearbox** in oil bath with metal gears.





# MTH 60



MOTOR TILLERS

- Honda GCV 170 engine with 166 cc displacement
- Petrol powered, ensures lower fuel consumption
- 1 forward gear
- Oil bath gearing transmission

**COD. 884270**

Engine Honda	GCV 170
Displacement	166 cc
Fuel	Gasoline
Speed	1 forward speed
Handle	height and side-adjustment
Trasmission	Oil bath gears
Tillers width	60 cm
Tillers	Ø 30 cm with tiller discs Ø 20 cm
Front travel wheel	included
Kit Shaft extension Tillers	optional
Weight*	40 kg
<b>Retail price</b>	<b>€ 785 - € 949,85*</b>



\*Weight without fuel





## MTL 60

**COD. 883660**

Engine	Loncin
Displacement	196 cc
Fuel	Gasoline
Speed	1 forward speed
Handle	height and side-adjustment
Trasmission	Oil bath gears
Tillers width	60 cm
Tillers	Ø 30 cm with tiller discs Ø 20 cm
Front travel wheel	included
Extension for tiller discs	optional
<b>Retail price</b>	<b>€ 625 - € 756,25</b>



## MTL 50

**COD. 883450**

Engine	Loncin LC1P65FC
Displacement	159 cc
Fuel	Gasoline
Speed	1 forward speed
Trasmission	belt
Tillers width	50 cm
Tillers	Ø 25 cm
Speed Tillers	90 rpm
Weight*	42.5 kg
<b>Retail price</b>	<b>€ 500 - € 605,00*</b>



\* Weight senza Gasoline

MOTOR TILLERS

## MOTOR TILLERS ACCESSORIES FOR MT 60

### EXTENSION FOR TILLER DISCS



80 CM

**COD. 733010**

**€ 54,45\***

### KIT FRONT TRAVEL WHEEL



**COD. 726690**

**€ 48,40\***





# Your planting helper





## POWERFUL AND RAPID

Blue Bird's wide range of motor pumps meets all the needs of individuals and professionals. Irrigating, watering, and draining are the three main actions that are enhanced by quality, sturdiness, and speed. In addition, muddy water motor pumps are capable of handling debris up to 8 mm in diameter. The range includes models equipped with HONDA engine and KOSHIN engine, one of the world leaders in the industry which has been a close partner with Blue Bird for more than 30 years.

Blue Bird's extensive range includes motor pumps with 1", 2" and 3" couplings, as well as a high-pressure model for special usages. High-quality materials, powerful motors, and mechanical construction place Blue Bird motor pumps at the top of their class and results. The example speaks for itself: after 100 hours of operation in muddy water, STV motor pumps maintain 10% higher flow rate and 30% higher pressure than clear water models.



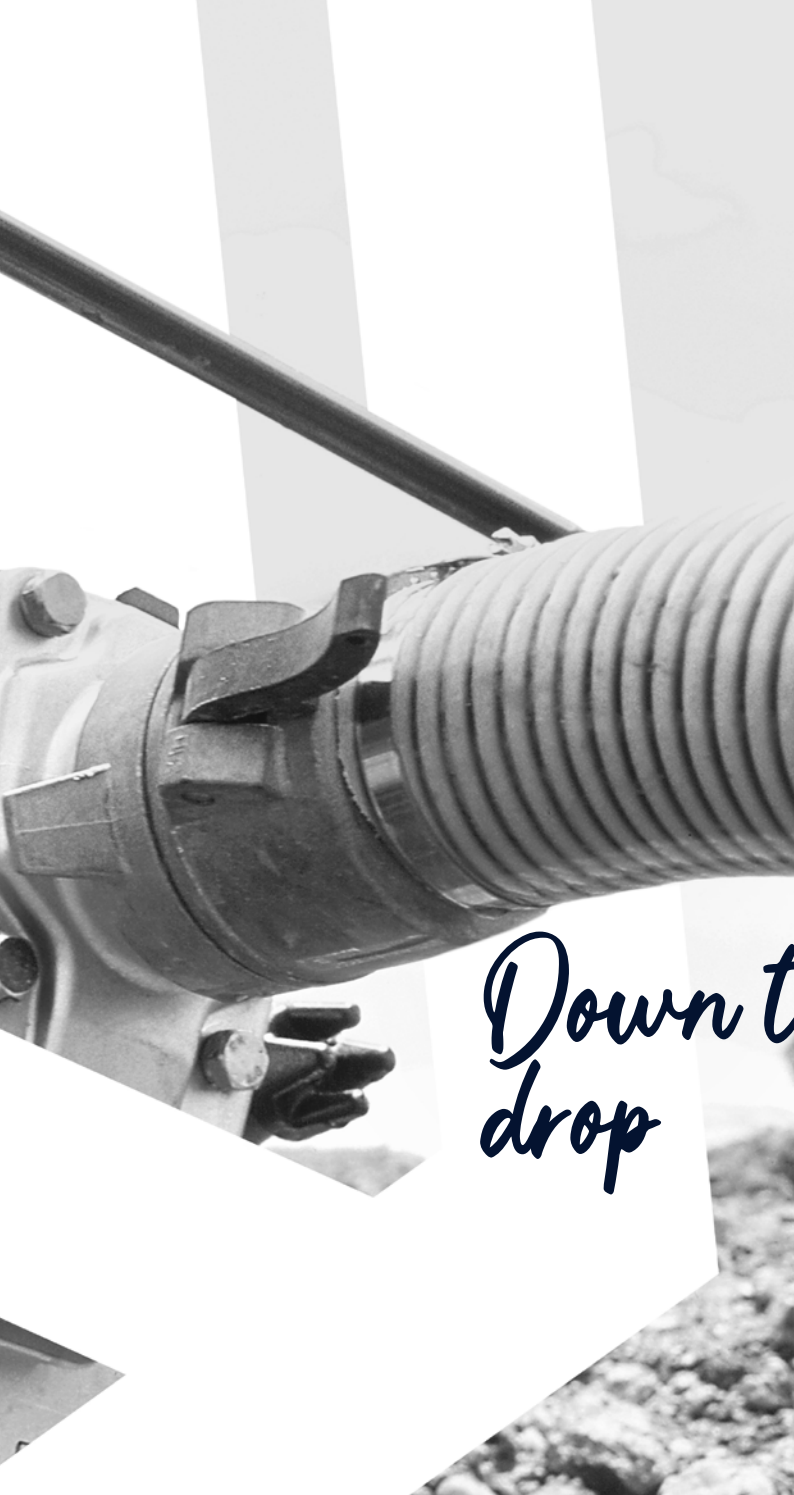

## ALWAYS UP FOR ACTION

The Blue Bird Water category includes the wide range of motor pumps for handling all types of water, including muddy ones. Powerful, lightweight, and reliable, they are used in multiple sectors, including construction, and for interventions due to floods or dangerous water spills.

*Down to the last drop*

**WATER**

Motor pumps

PAG 138



## MOTOR PUMPS

- Powerful and reliable, ideal for watering gardens and small crops, for application in the building sector, for draining garages and cellars.
- Indispensable aid for irrigating, watering and emptying large basins with extreme speed by extracting water from ponds or cisterns.
- The range features 1" 2" 3" models and a high pressure model for special applications.



01. KOSHIN K180 engine

02. Pump

**01. KOSHIN K 180 engine:** with recoil starter, it guarantees low noise and low vibrations.

**02. Pump:** usable for both muddy and sandy waters, equipped with silicone-based gaskets that guarantee a longer life.



# WP 341



- 2-stroke engine with 25 cc displacement
- Low weight
- Connection diameter 1"
- Maximum flow rate 100 l/min

*Liters of power  
at your service*

### COD. 879530

Engine Kendo	IE36FN - 2 tempi - 32.6 cc
Power	0.9 kW (1.2 CV) 8000 rpm
Fuel	Mixture 2% synthetic oil
Hose couplings Ø	1"
Max. lift	30 m
Max. delivery	100 l/min
Max. suction head	8 m
Net weight*	8 kg
Dimensions	355 x 285 x 395 mm
Retail price	€ 200 - € 242,00*



\* Weight without fuel and oil

# SEV-50X

- 179 cc 4-stroke engine
- Petrol powered
- Connection diameter 2"
- Maximum flow rate 620 l/min

*Every drop counts*

### COD. 878640

Engine Koshin	K 180 - 4 stroke - 179 cc
Power	3.1 kW (4.2 CV) 3600 rpm
Fuel	Gasoline
Hose couplings Ø	2"
Max. lift	25 m
Max. delivery	620 l/min
Max. suction head	8 m
Net weight*	24.2 kg
Dimensions	514 x 410 x 426 mm
Retail price	€ 420 - € 508,20*



\* Weight without fuel and oil



## SEV-80X

### COD. 878650

Engine Koshin	K 180 - 4 stroke - 179 cc
Power	3.1 kW (4.2 CV) 3600 rpm
Fuel	Gasoline
Hose couplings Ø	3"
Max. lift	25 m
Max. delivery	1050 l/min
Max. suction head	8 m
Net weight*	27.7 kg
Dimensions	553 x 435 x 483 mm
<b>Retail price</b>	<b>€ 475 - € 574,75*</b>



\* Weight without fuel and oil

## SEH-50X

### COD. 871220

Engine Honda	GX 120 - 4 stroke - 118 cc
Power	2.6 kW (3.5 CV) 3600 rpm
Fuel	Gasoline
Hose couplings Ø	2"
Max. lift	30 m
Max. delivery	600 l/min
Max. suction head	8 m
Net weight*	24 kg
Dimensions	493 x 377 x 415 mm
Note	Oil level alert
<b>Retail price</b>	<b>€ 635 - € 768,35*</b>

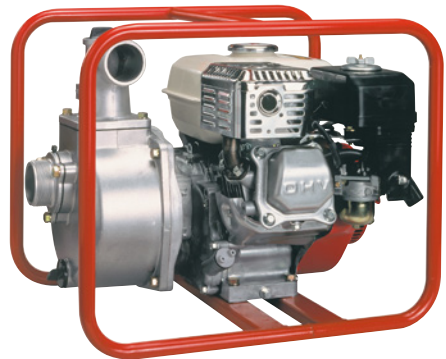

\* Weight without fuel and oil

## SEH-80X

### COD. 871230

Engine Honda	GX 160 - 4 stroke - 163 cc
Power	3.6 kW (4.9 CV) 3600 rpm
Fuel	Gasoline
Hose couplings Ø	3"
Max. lift	26 m
Max. delivery	930 l/min
Max. suction head	8 m
Net weight*	34 kg
Dimensions	530 x 399 x 473 mm
Note	Oil level alert
<b>Retail price</b>	<b>€ 710 - € 859,10*</b>

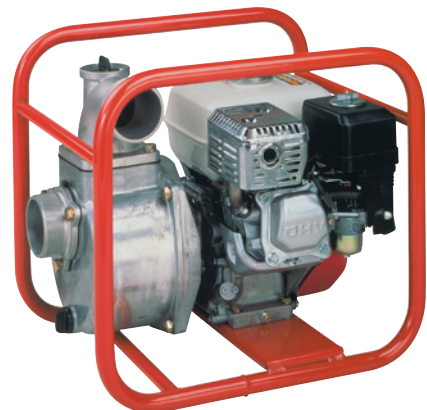

\* Weight without fuel and oil



# SERH-50B

**COD. 872620**

Engine Honda	GX 160 - 4 stroke - 163 cc
Power	3.6 kW (4.9 CV) 3600 rpm
Fuel	Gasoline
Hose couplings Ø	2"
Max. lift	57 m
Max. delivery	440 l/min
Max. suction head	8 m
Net weight*	34 kg
Dimensions	545 x 415 x 455 mm
Note	Oil level alert
<b>Retail price</b>	<b>€ 1.040 - € 1.258,40*</b>



\* Weight without fuel and oil

# STV-50X / STV-80X

**COD. 880980**
**COD. 881000**

Engine Koshin	K 180 - 4 stroke - 179 cc	K 180 - 4 stroke - 179 cc
Power	3.1 kW (4.2 CV) 3600 rpm	3.1 kW (4.2 CV) 3600 rpm
Fuel	Gasoline	Gasoline
Hose couplings Ø	2"	3"
Max. lift	26 m	26 m
Max. delivery	580 l/min	900 l/min
Max. suction head	8 m	8 m
Dimensione detriti	max 8 mm	max 8 mm
Net weight*	31 kg	32.9 kg
Dimensions	554 x 400 x 471 mm	593 x 425 x 528 mm
<b>Retail price</b>	<b>€ 560 - € 677,60*</b>	<b>€ 620 - € 750,20*</b>



\* Weight without fuel and oil





## **PROTECTION AND COMFORT AT THE TOP.**

Equipment, although evolved in terms of safety, is not enough if not accompanied by the appropriate clothing. With its new basic devices for personal protection, Blue Bird dresses the work of individuals and professionals. Because a job well done by the responsible choices of each.

The line of clothing and Accessories for personal protection Blue Bird are made with technical fabrics and functional materials that guarantee high comfort, resistance and protection. Particular attention has been given to breathability, elasticity and visibility, indispensable factors for any outdoor activity in any climate. The style is decided, linear, determined, like the spirit Blue Bird.





## PRACTICALITY TECHNICALITY SAFETY

The Blue Bird line dedicated to technical clothing presents the essential items for gardening, maintenance of the green, the garden and woodwork. Jacket, pants, helmet, gloves and glasses allow you to face any intervention combining excellent protection and great freedom of movement. Full of Blue Bird.

*High style  
protection*

# DEVICES OF PERSONAL PROTECTION & GADGET

Devices of personal protection	PAG 144
Gadget	PAG 146



### FOREST JACKET 4 WAY STRETCH

Forest jacket suitable for offering protection and functionality. Made with durable and waterproof materials, such as reinforced nylon with a Teflon finish, which gives elasticity to 4 directions. Features Kevlar and Cordura inserts to ensure greater resistance to external agents that, combined with the presence of 3M reflective bands help increase visibility.

Size S-XXL

FOREST JACKET	<b>COD. 755010/SIZE</b>
<b>Retail price</b>	<b>€ 125 - € 151,25*</b>



**VERSATILITY  
CONVENIENCE  
SAFETY**



### CHAINSAW RESIST TROUSERS

Class 1 chainsaw resist trousers specially designed to offer safety and performance with high fit and increased wear resistance. They are made with a 4-way stretch fiber and finished with Teflon, reinforced with Kevlar and Cordura inserts to protect from abrasions and impacts and feature fabric.

Size S-XXL

CLASS 1 CHAINSAW RESIST TROUSERS	<b>COD. 755020/SIZE</b>
<b>Retail price</b>	<b>€ 175 - € 211,75*</b>



### GARDEN TROUSERS

Garden Trousers offers flexibility thanks to the 4-way stretch polyester fabric. Protection guaranteed with 600D fabric and felt at the knee and lower front. The ventilation system with zipper on the back ensures breathability and comfort. An ideal pant for use in the garden, offering optimal protection during activities.

Size S-XXL

GARDEN TROUSERS	<b>COD. 755030/SIZE</b>
<b>Retail price</b>	<b>€ 69 - € 83,49*</b>





### HELMET WITH FACE SHIELD AND HEADSET

The nylon mesh (polyamide PA) guarantees a robust defense, the headset offers comfort with its soft padding, the head protection ensures total safety. The acoustic protection capsules, with sound insulation, complete the experience, ensuring a protected and serene working environment.

HELMET WITH FACE SHIELD AND HEADSET	<b>COD. 752710</b>
<b>Retail price</b>	<b>€ 29 - € 35,09*</b>



### PROTECTIVE GLOVES

Professional green gloves: elasticity and velcro closure for a perfect fit. Breathable, provide optimal comfort and protection during outdoor activities

Size 9"	<b>COD. 755090</b>
Size 10"	<b>COD. 755100</b>
Size 11"	<b>COD. 755110</b>
Size 12"	<b>COD. 755120</b>
<b>Retail price</b>	<b>€ 23 - € 27,83*</b>



### PROTECTIVE GOGGLES

Goggles are suitable for all activities that require visual security. Lightweight and comfortable, convex lenses provide a wide protective cover. Available in transparent or colored.

TRANSPARENT	<b>COD. 755040</b>
YELLOW	<b>COD. 755050</b>
SUNGLASSES	<b>COD. 755060</b>
<b>Retail price</b>	<b>€ 6,50 - € 7,87*</b>



### BLUE BIRD SUSPENDERS FOR PANTS

The professional Blue Bird braces are the ideal accessory for workers dedicated to green care, gardening and activities in the WOOD. Carefully designed to meet the practical and functional needs of those who work outdoors, these braces offer a perfect combination of comfort and endurance.

UNIQUE SIZE	<b>COD. 755150</b>
<b>Retail price</b>	<b>€ 25 - € 30,25</b>



**WALL DISPLAY DOUBLE USE**

Wall display double use **COD. 841280**



**CENTRAL DISPLAY STAND (GONDOLA STYLE)**

Central display stand **COD 841370/2023**



**INSTITUTIONAL GAZEBO**

INSTITUTIONAL GAZEBO **COD. 6901330**



**BEACHFLAGS**

OUTDOOR H310 **COD. 6903850**  
 INDOOR H260 **COD. 6903860**





We are  
Blue Bird



**T-SHIRT BLUE BIRD BLACK**

Size S-XXL

T-SHIRT BLACK

**COD. 6904150/SIZE**



**BLUE BIRD CAP**

CAP

**COD. 6904400**



**BLUE BIRD GILET**

Size S-XXL

GILET

**COD. 6904410/SIZE**

*We cut  
new horizons*

**NATURALLY  
TOGETHER**









If you care for the green with responsibility in the Blue Bird Planet you will feel at home: we respond directly to all requests offering guidance and advice. Our headquarters are in Italy, just an email or a phone call to our customer service.

Customer service  
**+39 0445 314138**

[www.bluebirdind.com](http://www.bluebirdind.com)

## WHERE TO FIND OUR PRODUCTS

All our distributors share with us the passion for the green and its responsible care. Trust them, they are experts in Blue Bird machinery and will help you find the right product for your needs. In our website you can discover the nearest dealer to you.

*Become part of  
Blue Bird planet*



You will find tools, information, advice!



### GENERAL WARNINGS

The prices indicated \* in this catalog are with VAT.

The prices indicated in this catalog are updated as of March 1, 2024. BLUE BIRD INDUSTRIES reserves the right to change the sales prices.

With the publication of this catalog the previous catalogs lose all validity.

No rights can be asserted on the basis of data or images in this catalogue. We reserve the right to make changes in terms of technology, shape, colours, tools and price.

The delivery terms indicated by the company will be observed with reasonable punctuality, compatibly with the availability of the goods and in no case can the delay be the cause of requests for indemnity or cancellation of the contract.

Complaints received 8 (eight) days after receipt of the goods are not accepted.



### GENERAL SALES CONDITIONS

Can be consulted through this QR code



### SECURITY GUARANTEED

BLUE BIRD INDUSTRIES satisfies the ISO 9001 standards representing the high commitment in all organizational sectors for a complete quality management and respect for the environment.



# **BLUEBIRD**

## **INDUSTRIES**

[bluebirdind.com](http://bluebirdind.com)



Via Due Camini 19 - 36010 Zanè (VI)